



STAR WARS



10240



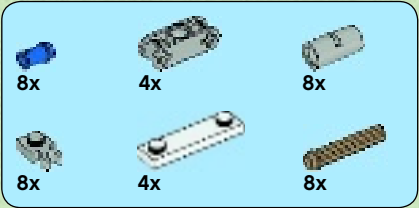
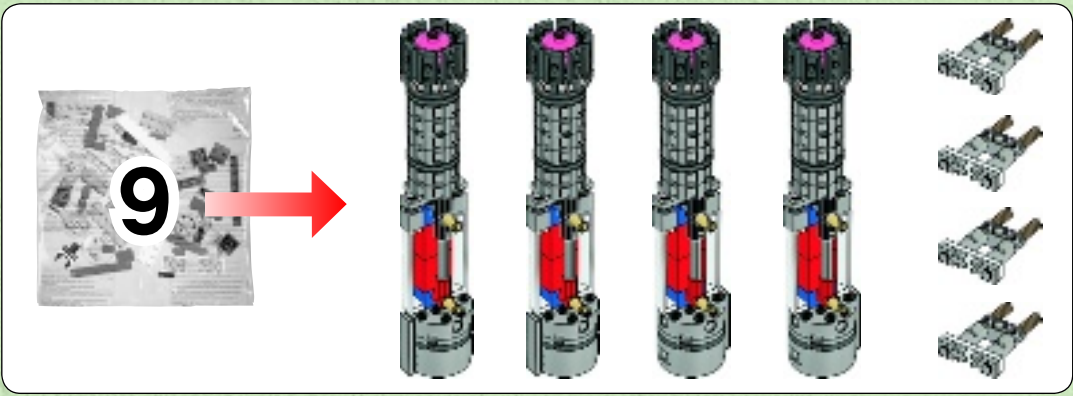

55

1

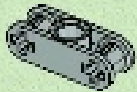

2

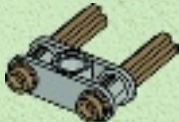

3

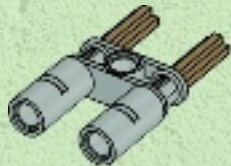

4

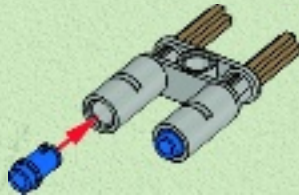

5

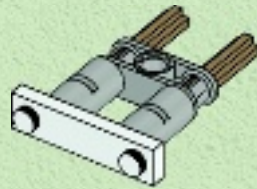

6

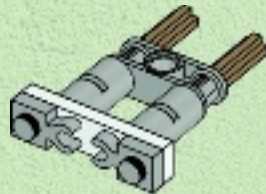

4x

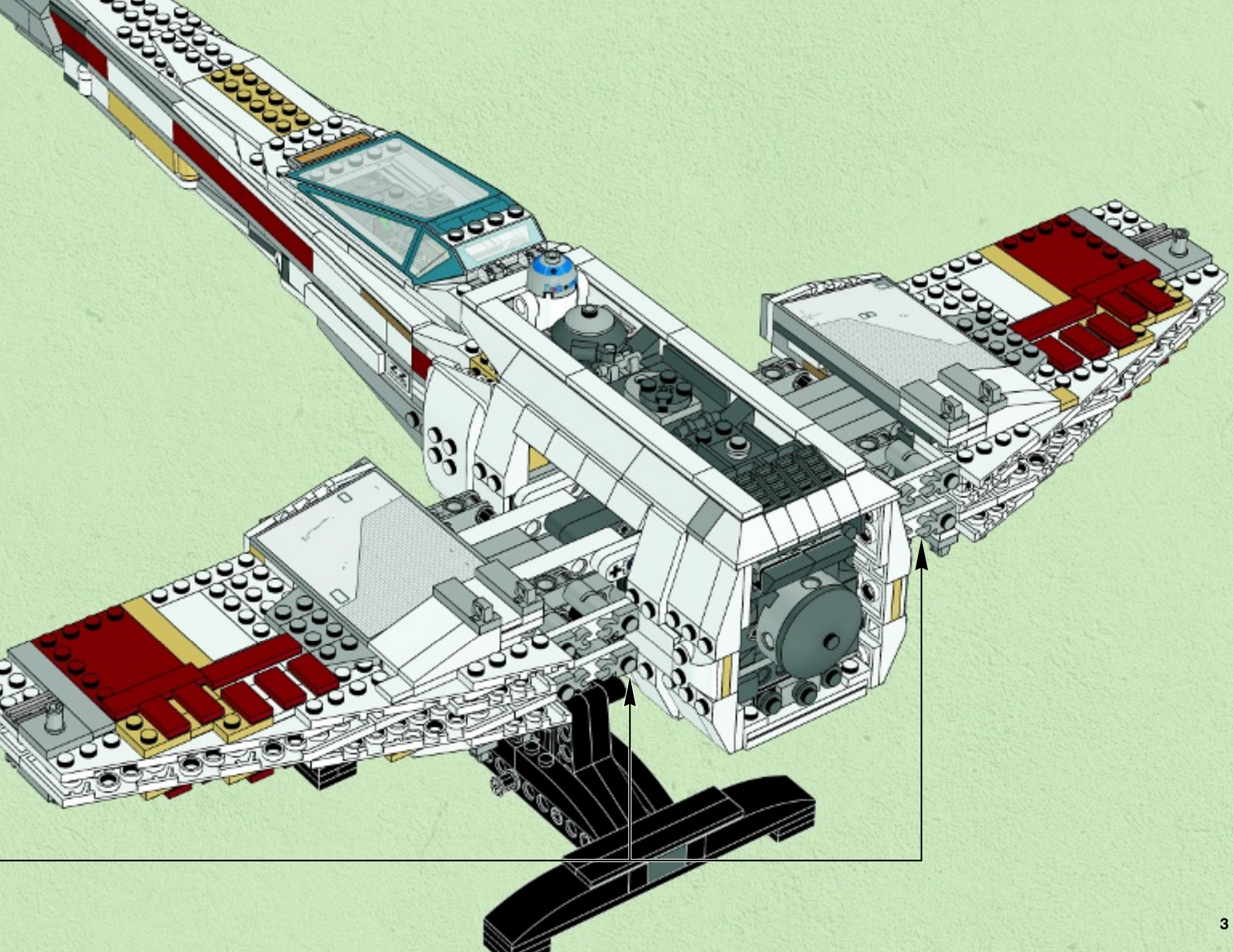

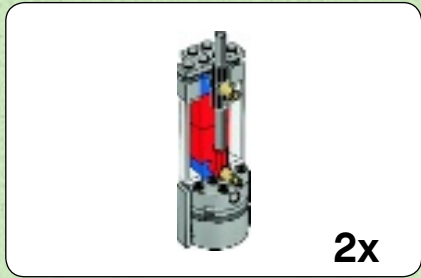
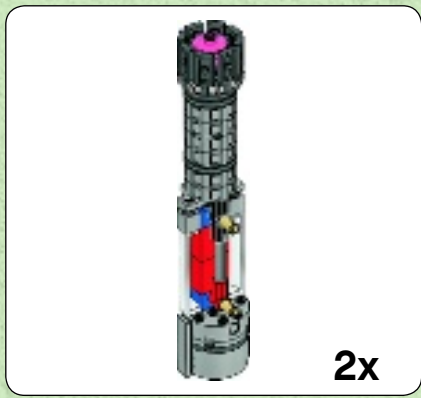

1

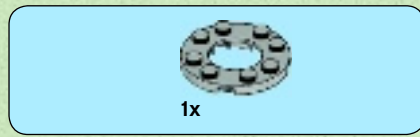

2



3



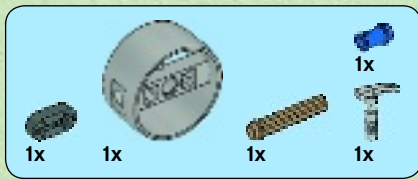

4

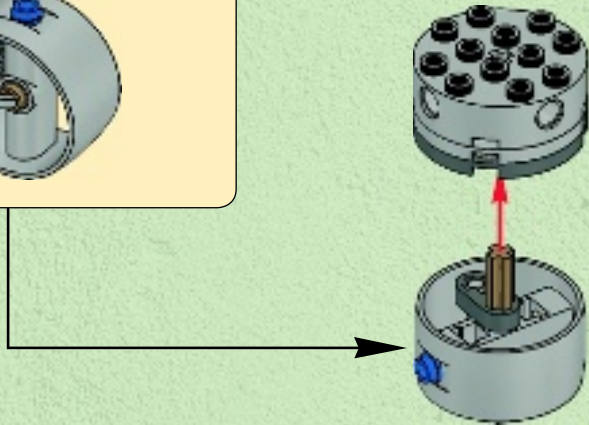
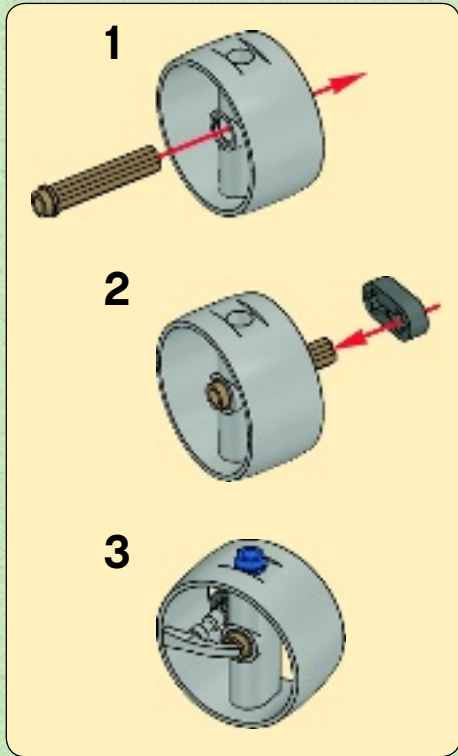

5

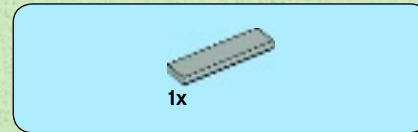
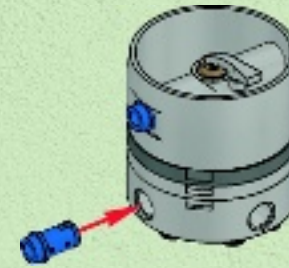
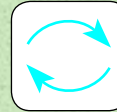

6

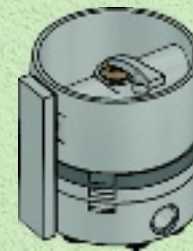



7

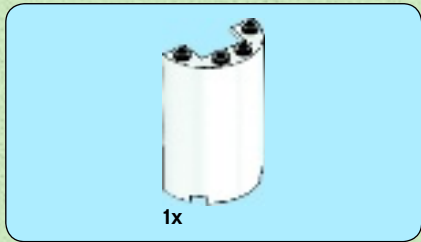
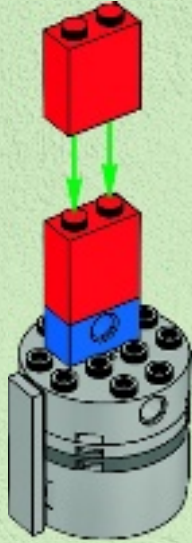
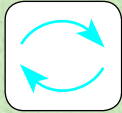

8

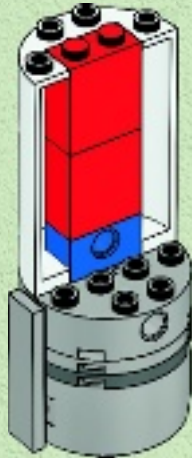

9

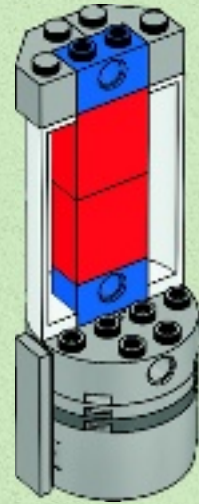

10

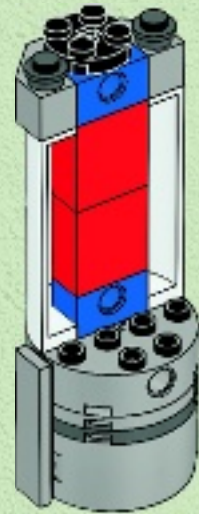

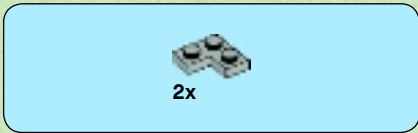

11

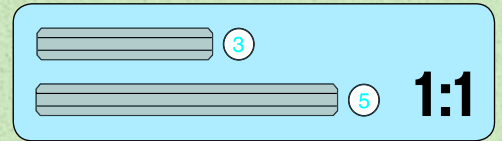
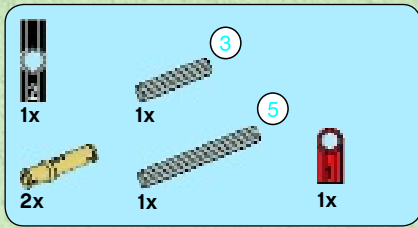
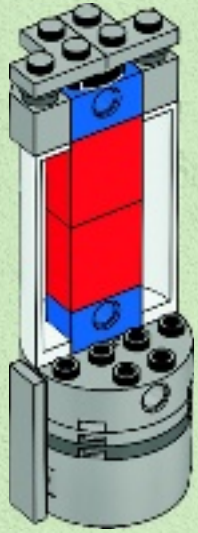

12

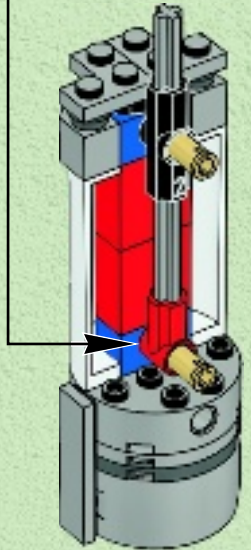
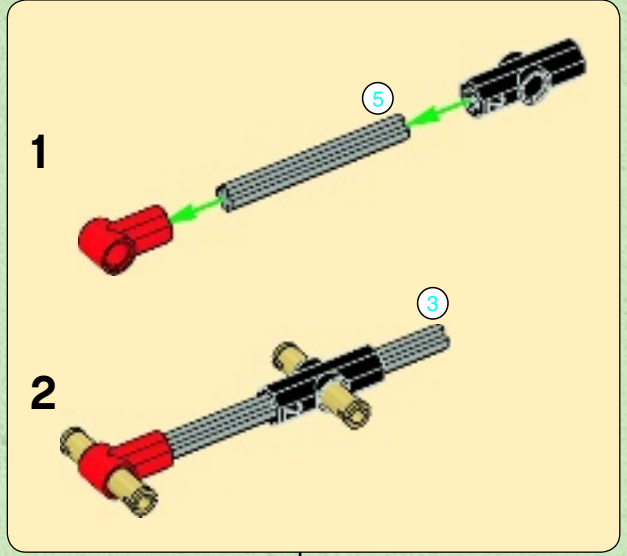

2x



2x

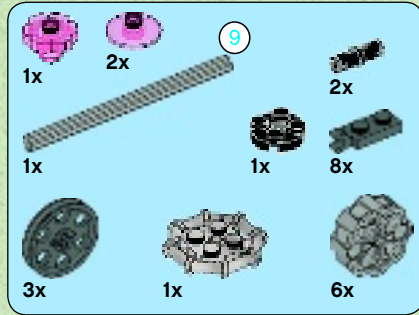

13

1



2

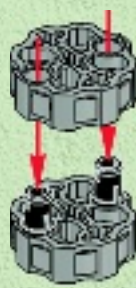

3



4

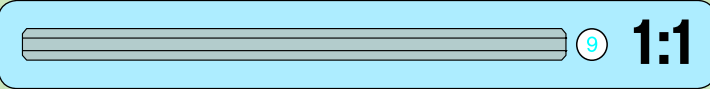

5



6



7



8



9

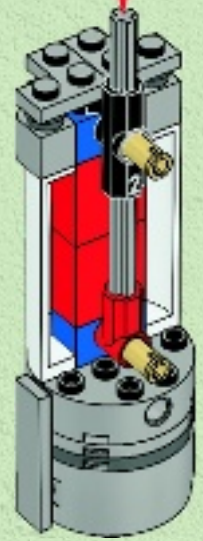
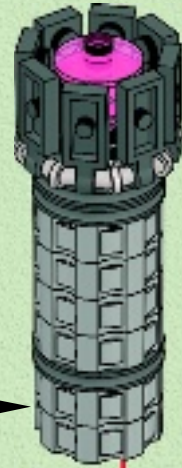
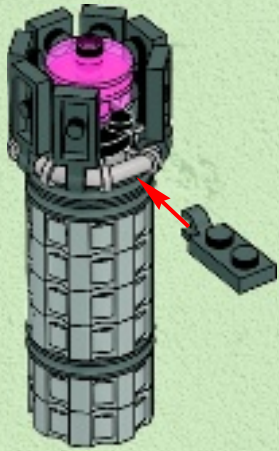

2x

56

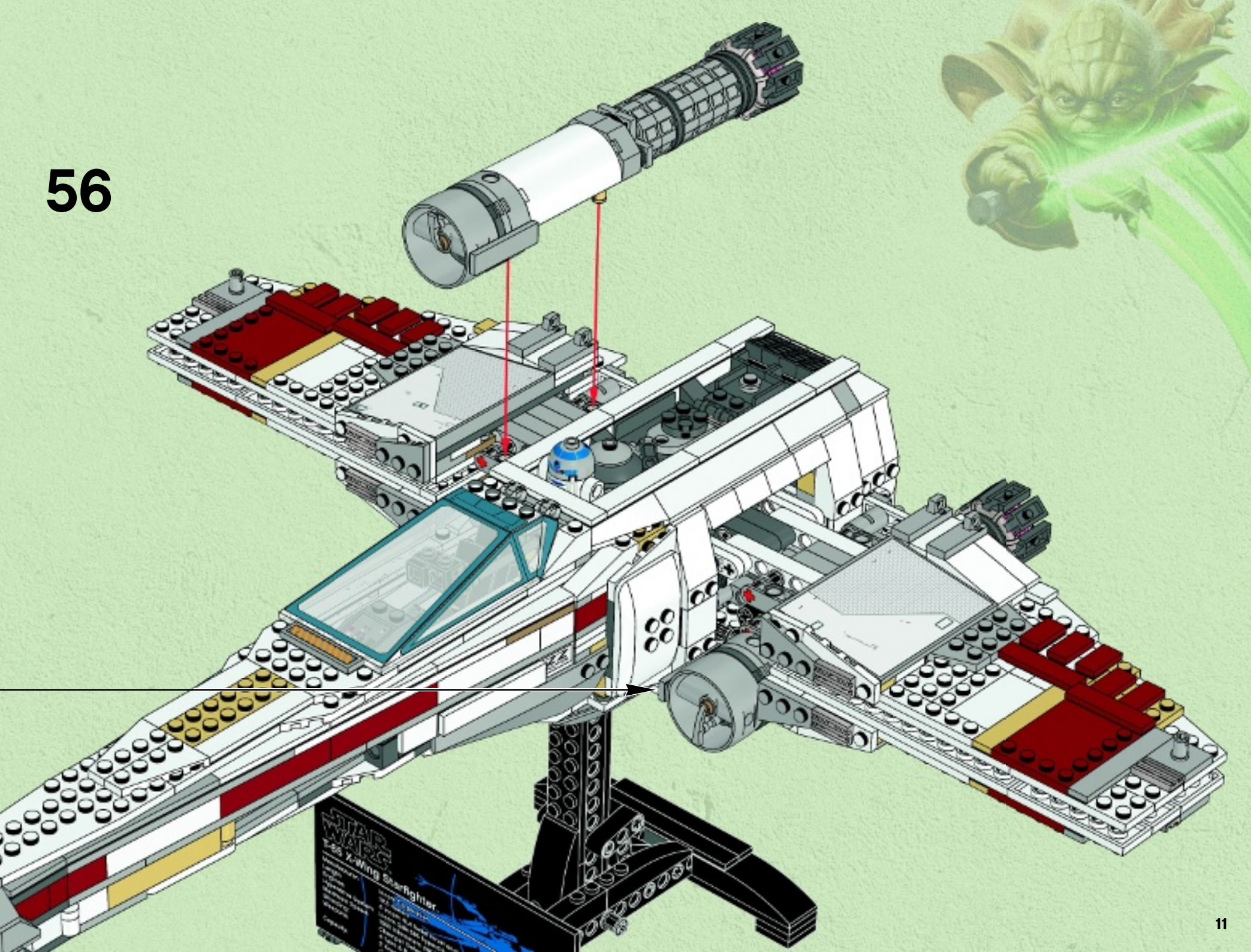

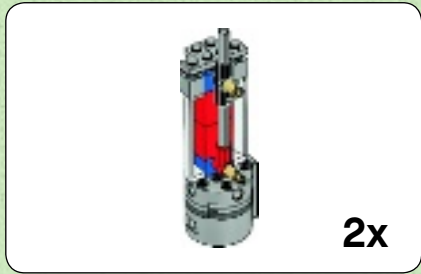
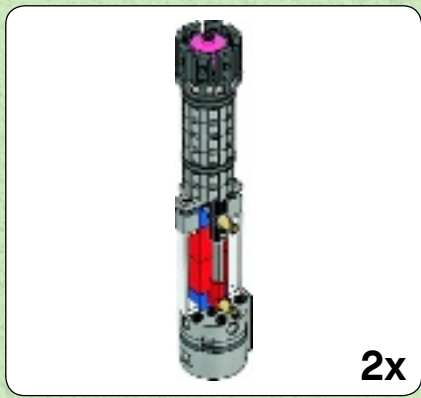

1

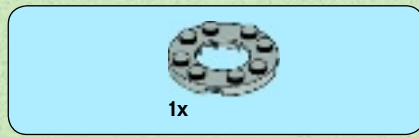

2

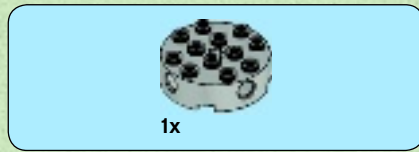

3



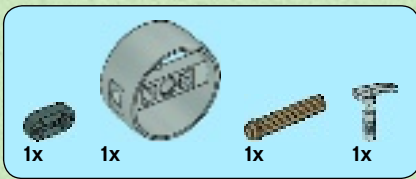

4

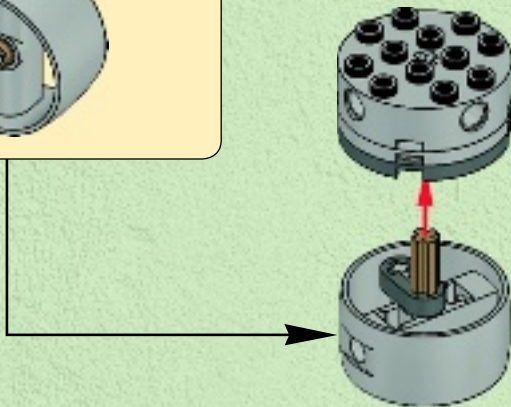
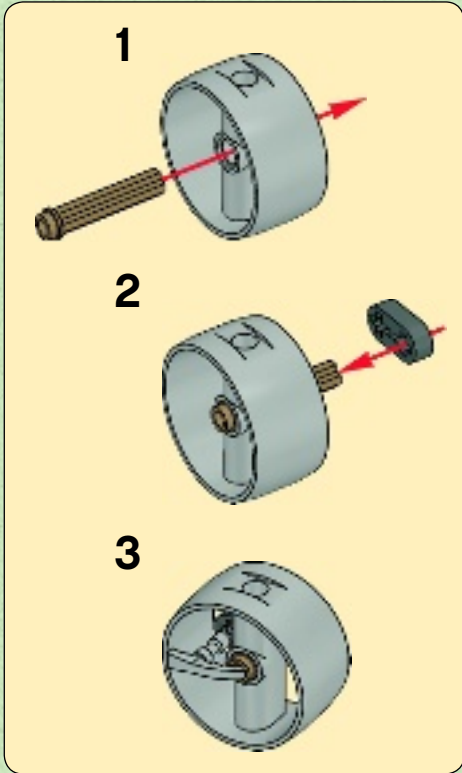

5

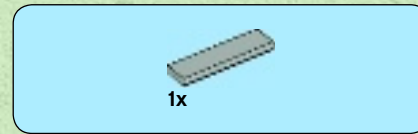
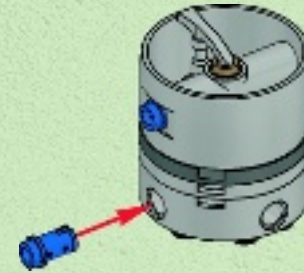
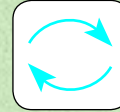

6

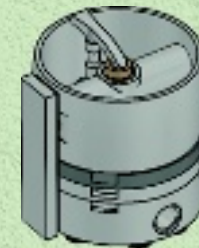



7

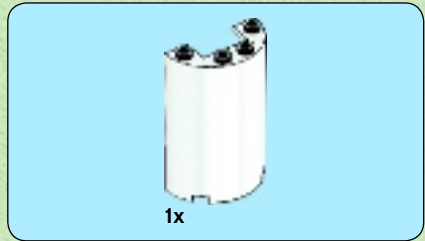
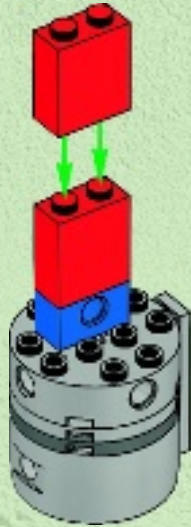

8

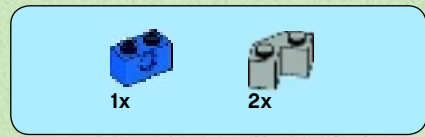
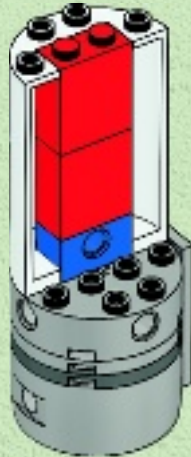

9

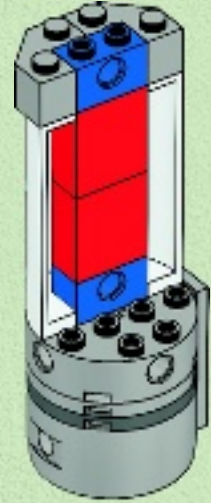

10

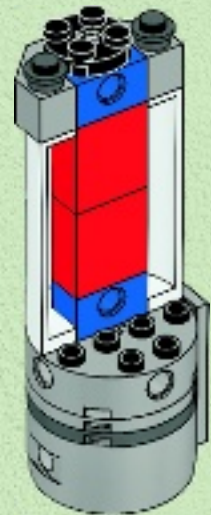

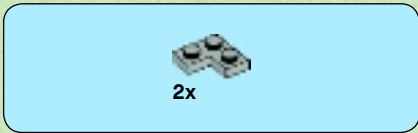

11

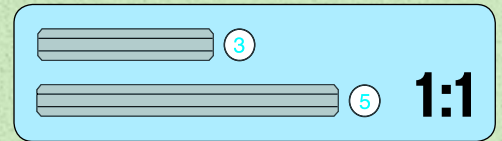
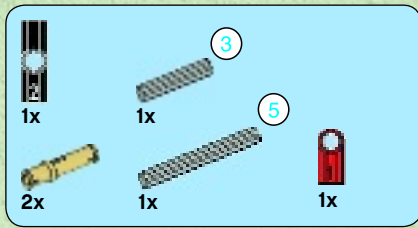
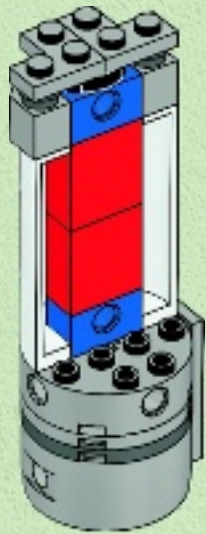

12

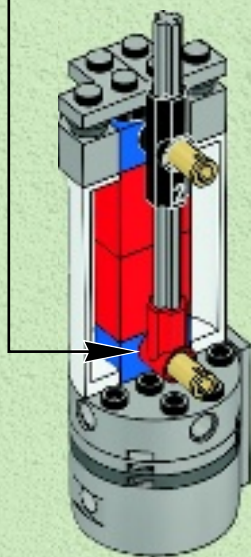
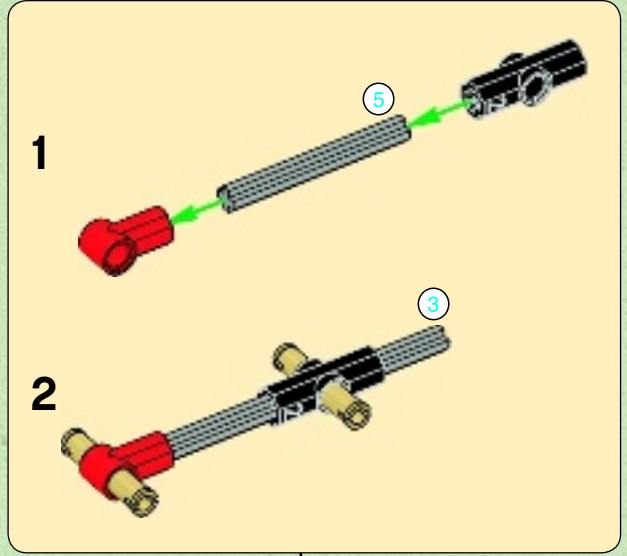

2x 15



2x

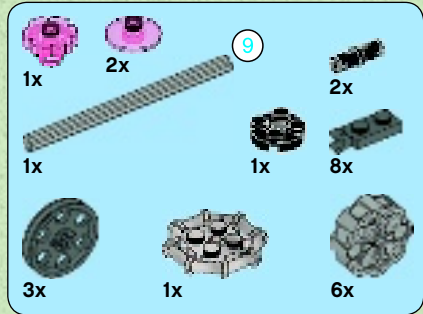

13

1



2

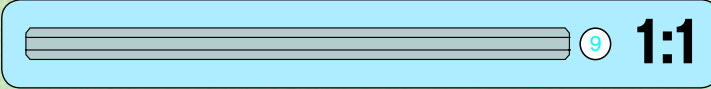
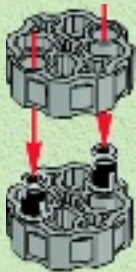

1:1

3



4



5



6

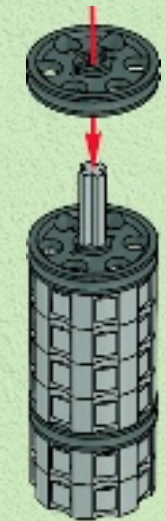

7



9

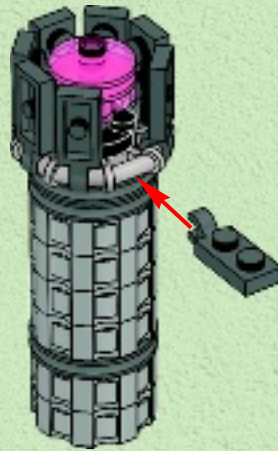

8

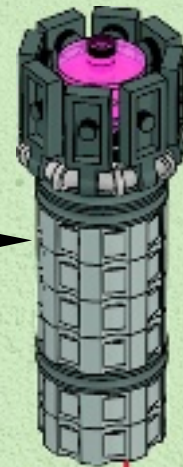

2x

57

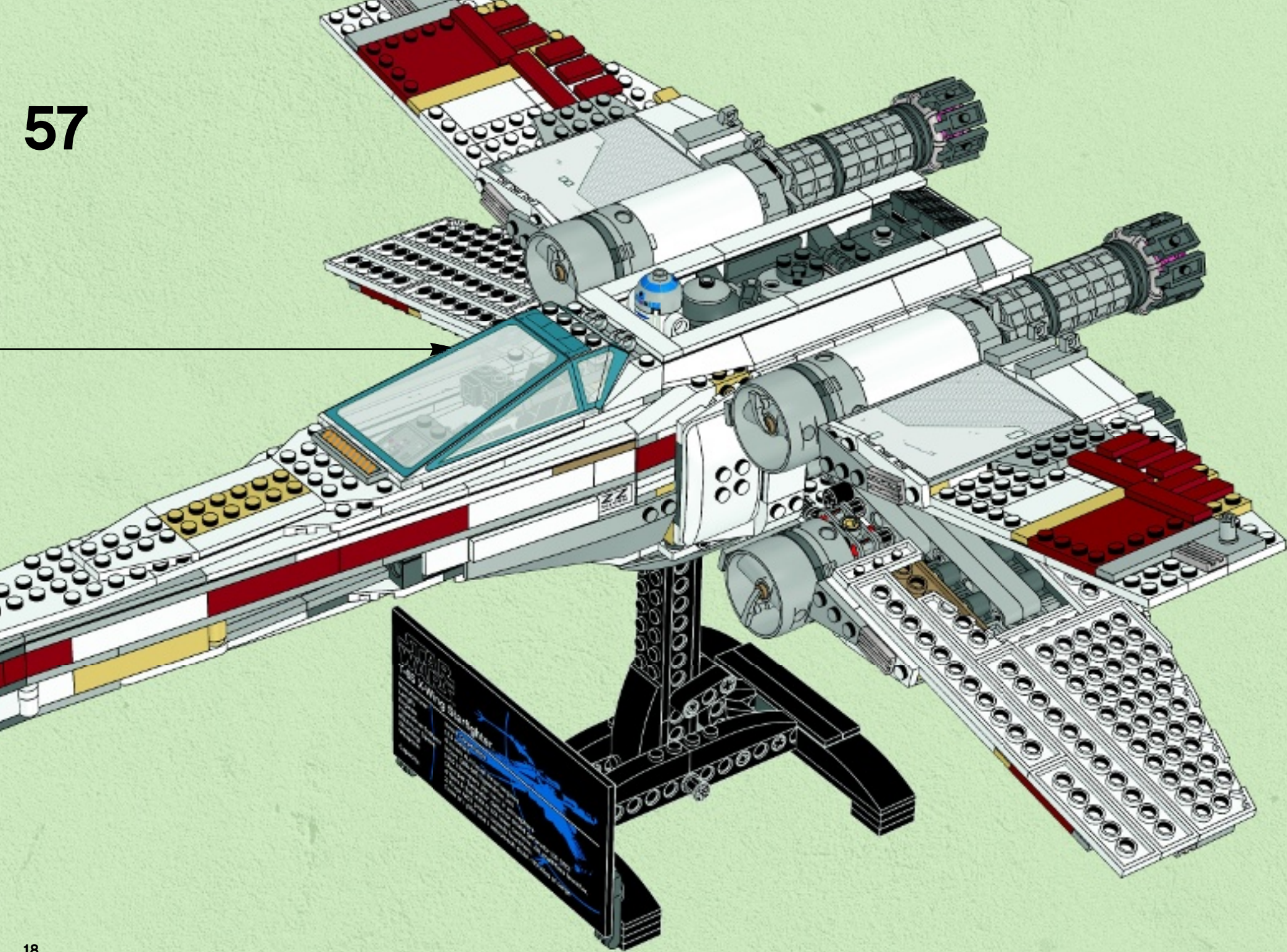

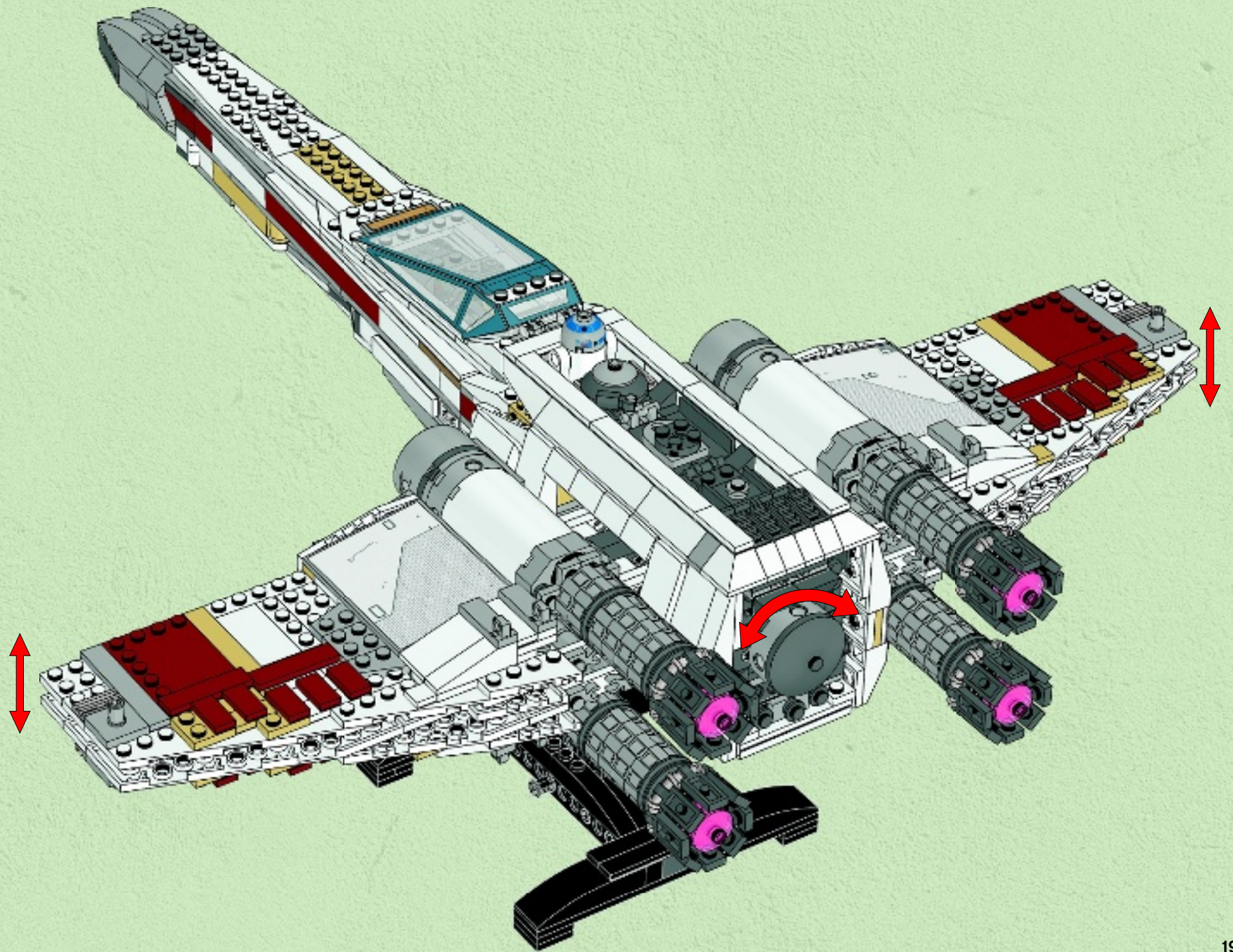

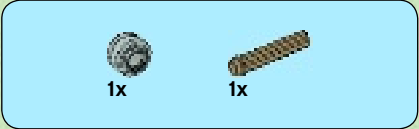
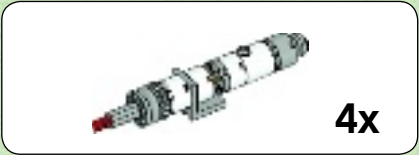
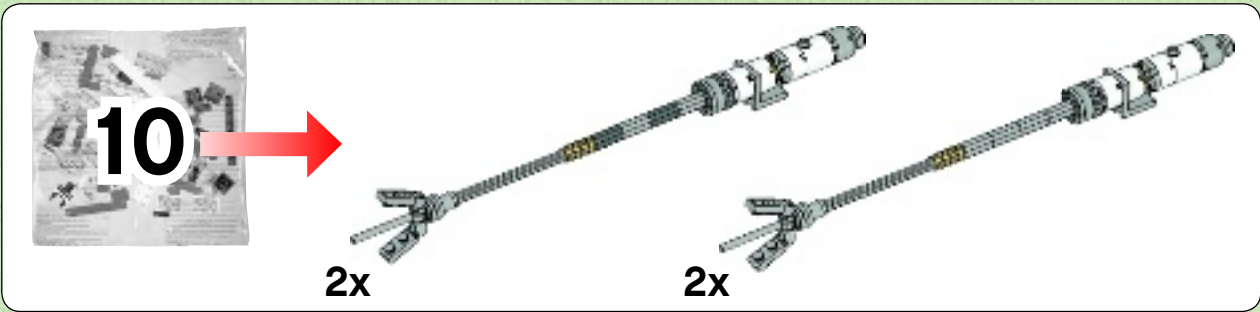

1

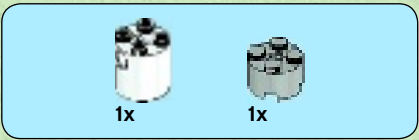
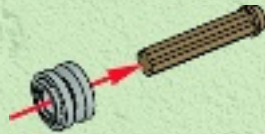

2

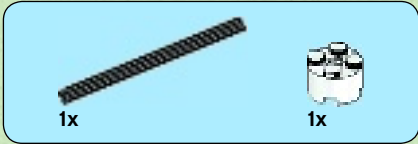
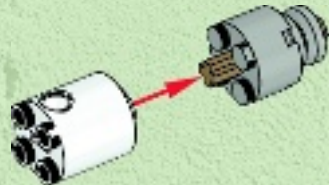

3

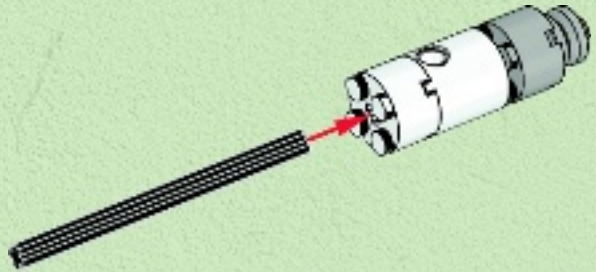

4

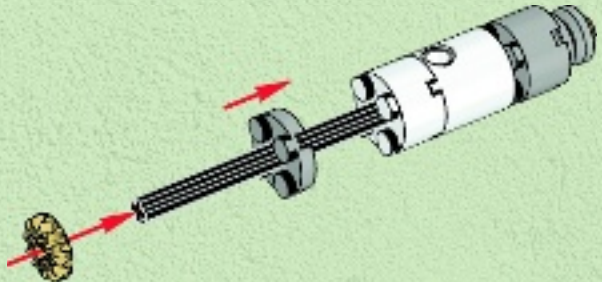

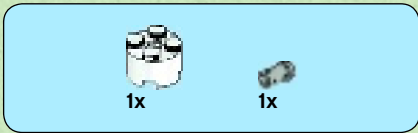

5

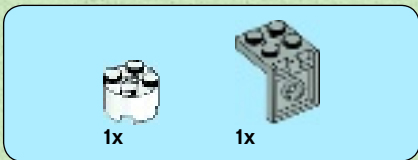
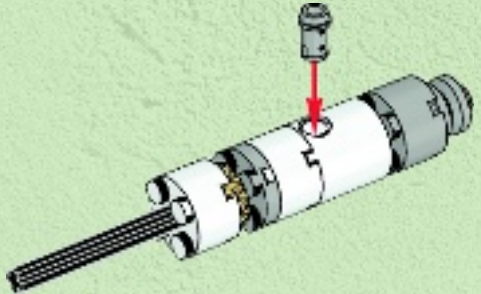

6

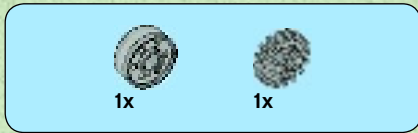
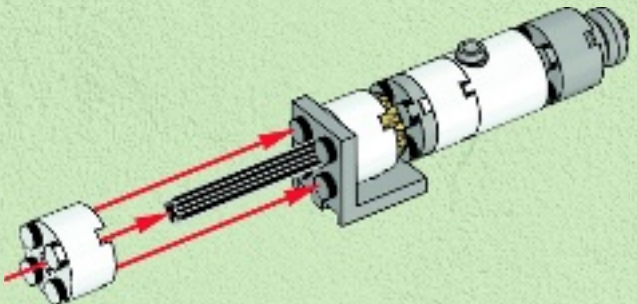

7

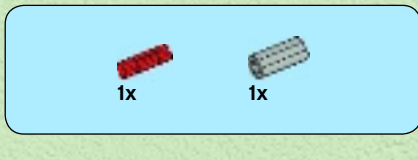
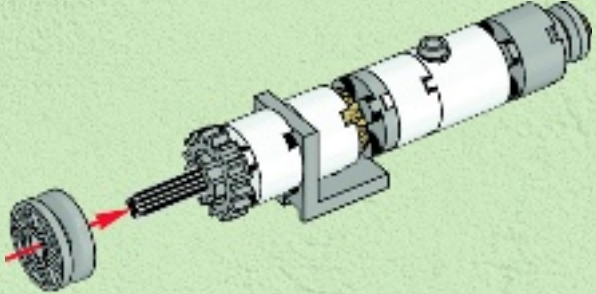

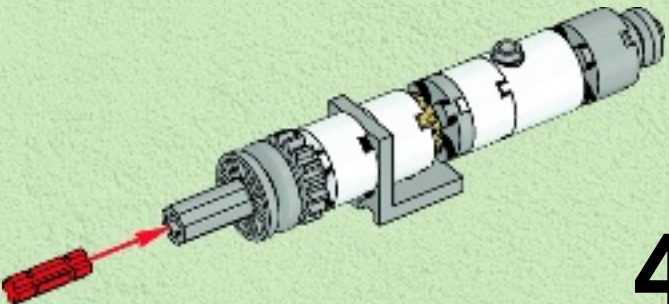

8

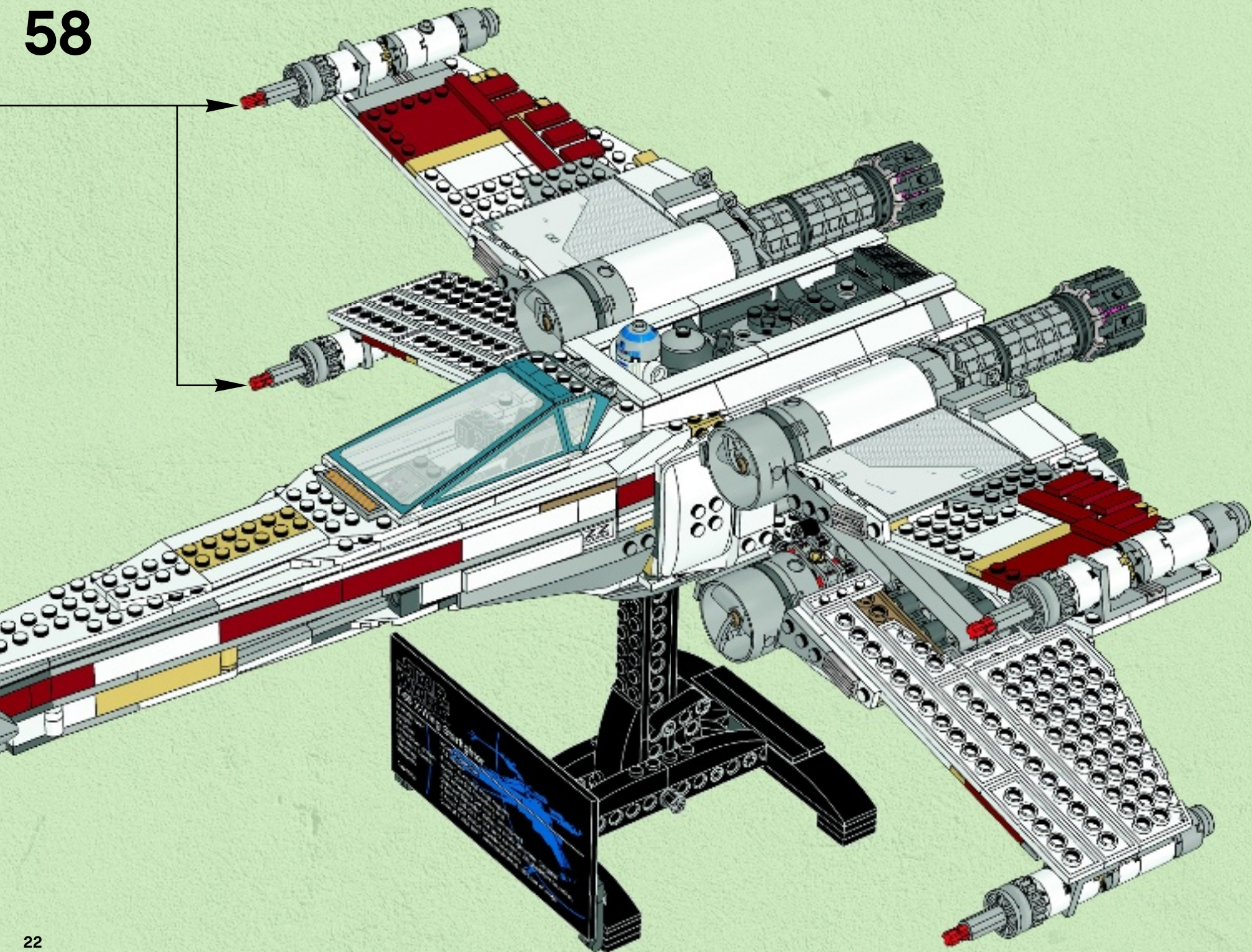

58



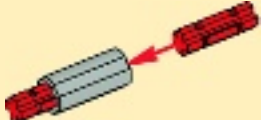
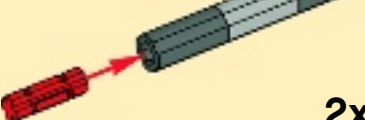

3x  1x  2x 

59

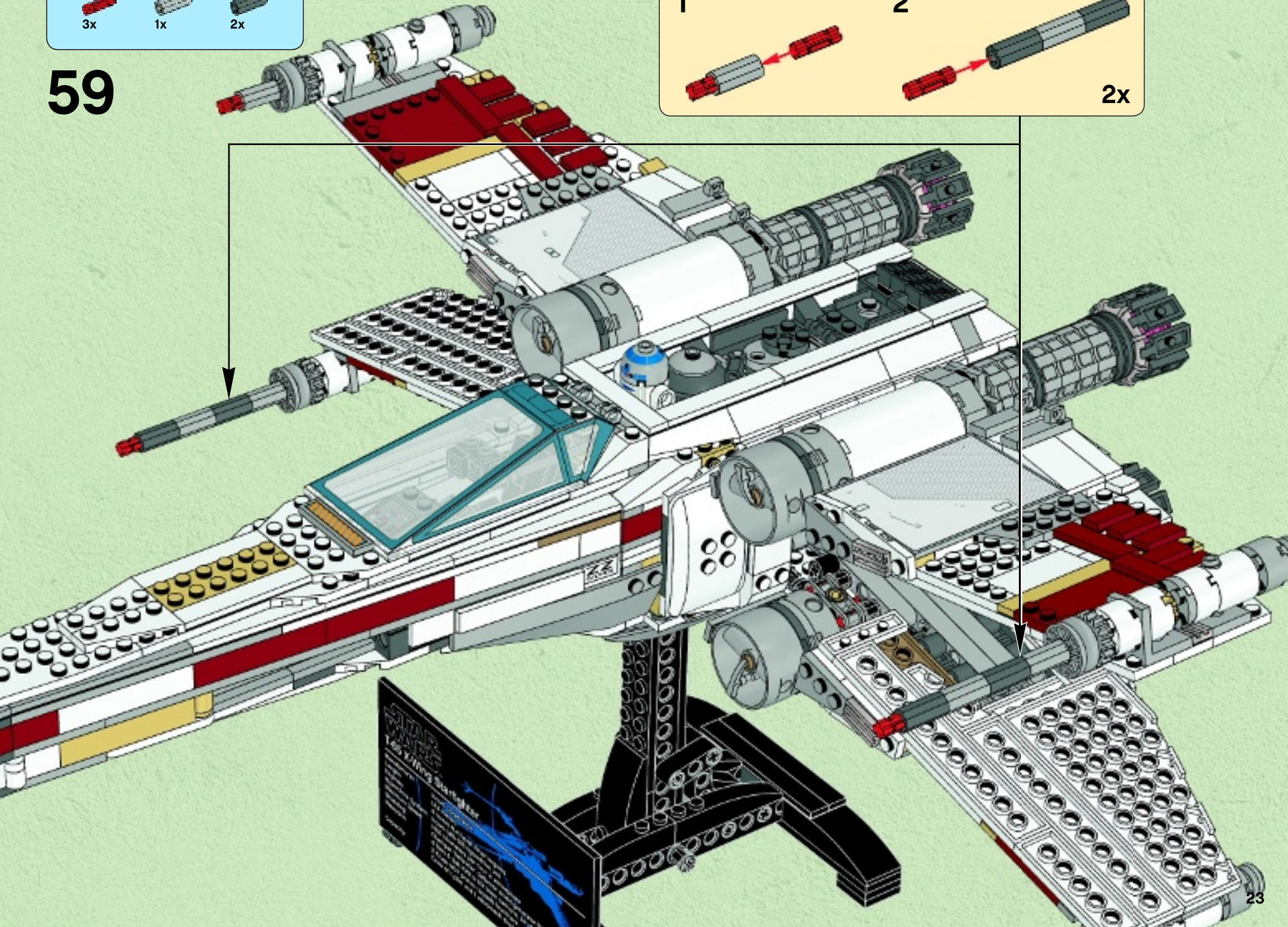
1  2  2x



3x  3x 

60

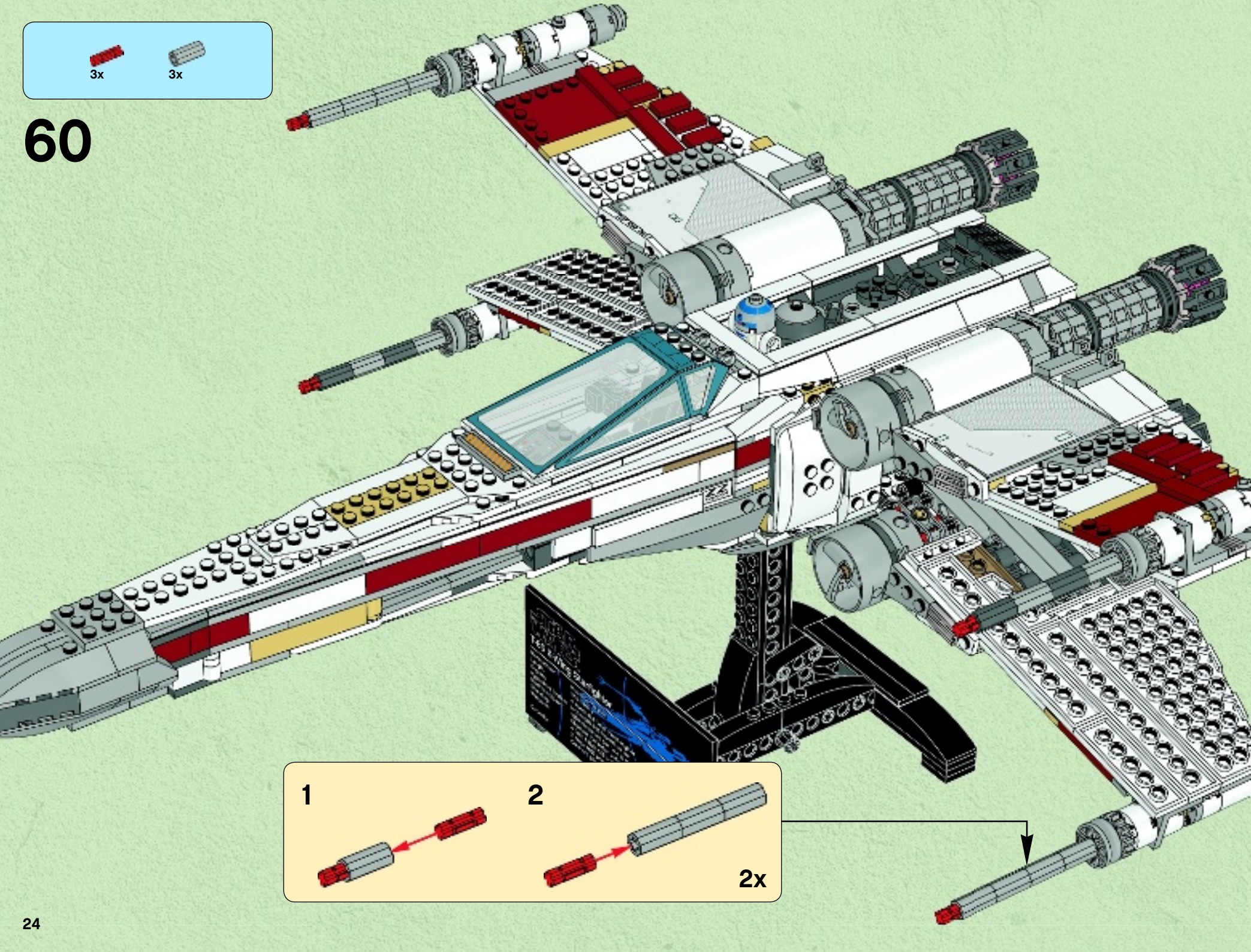

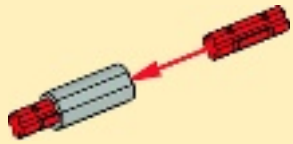
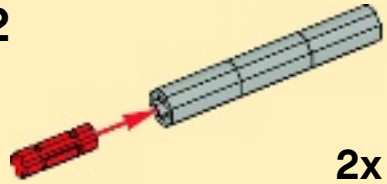
1  2  2x

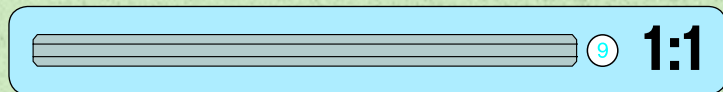
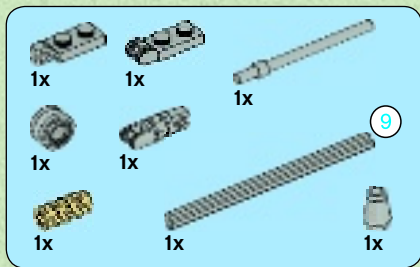

61

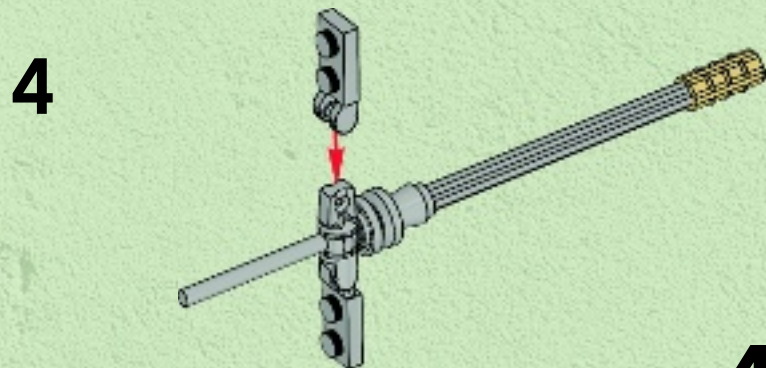
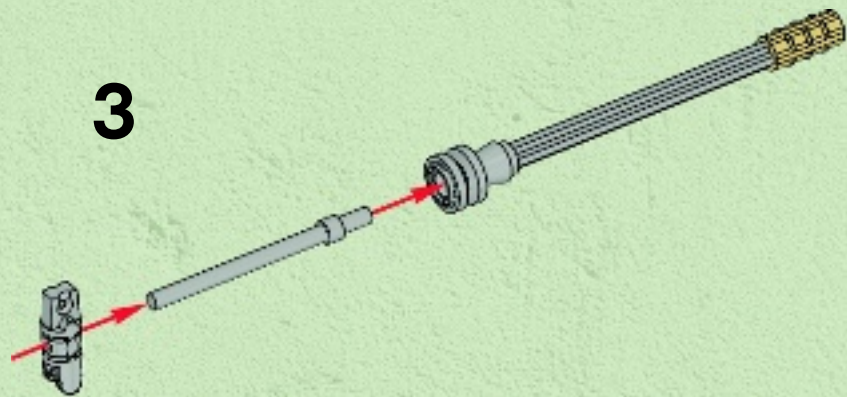
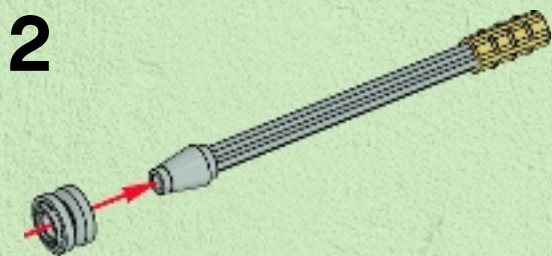
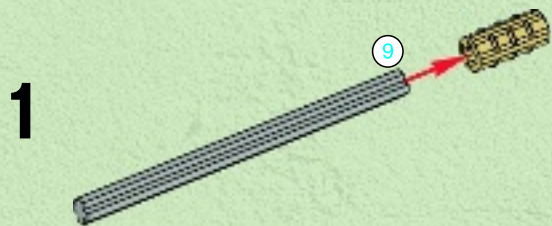

4x



61

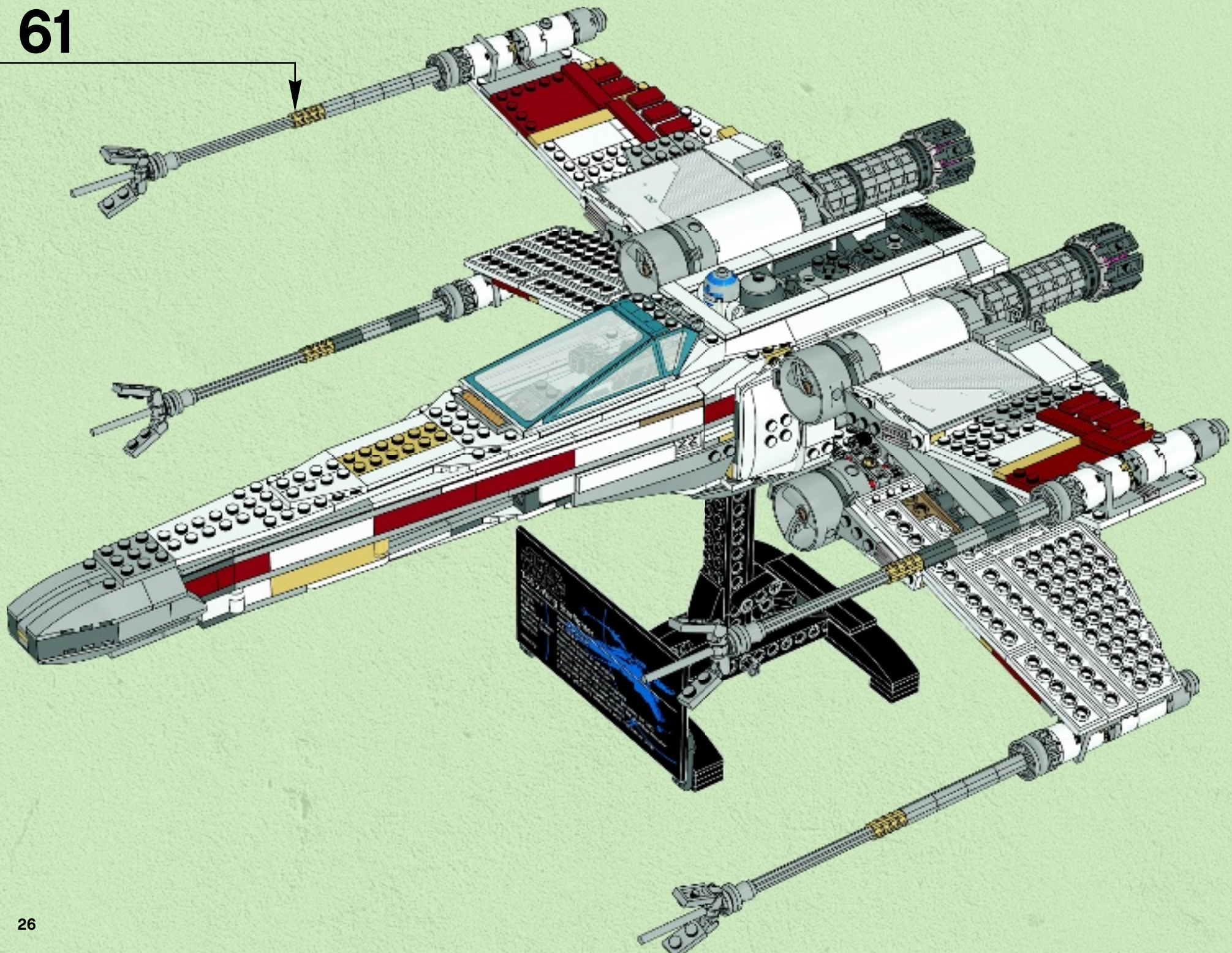

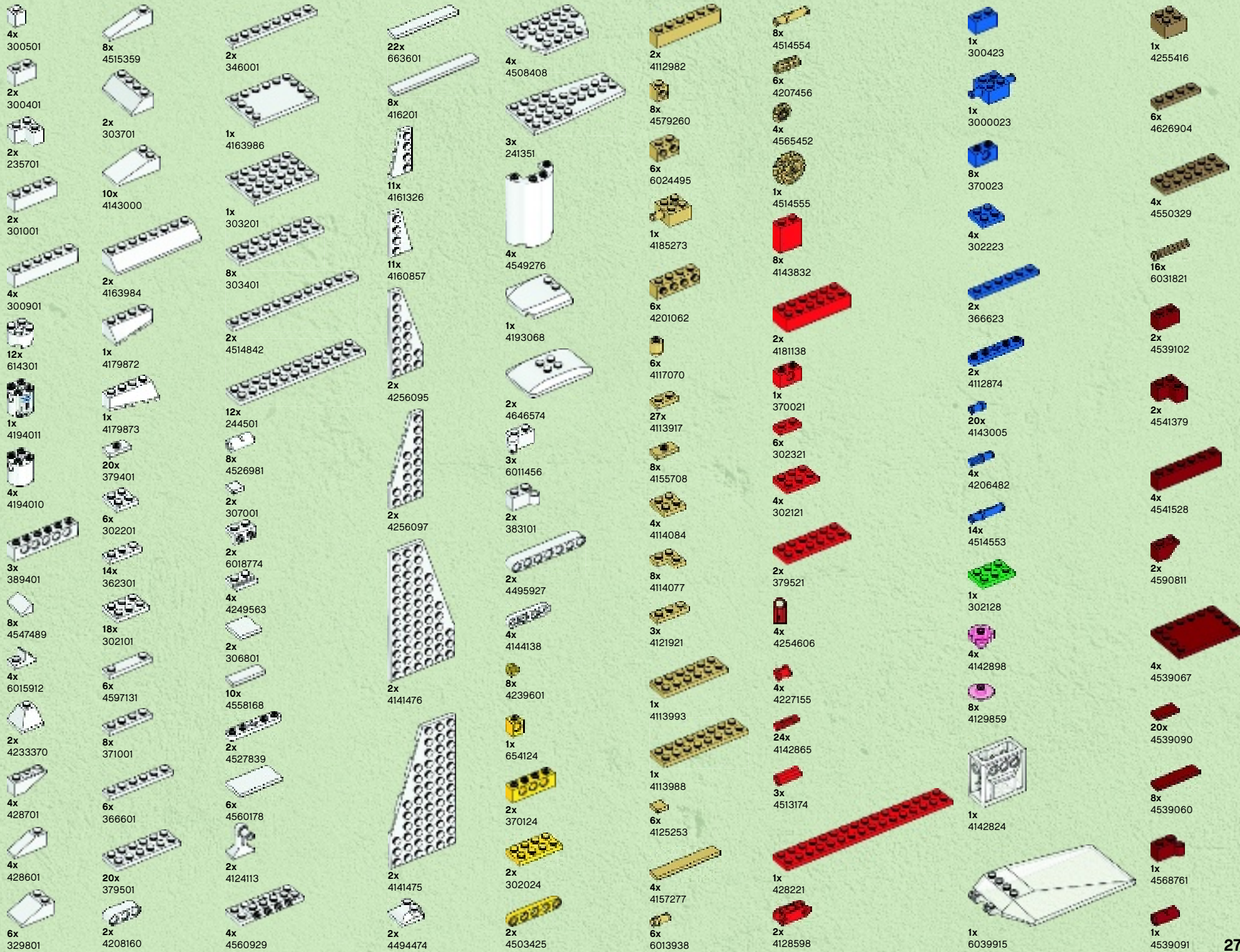

2x
300126



2x
300926



2x
407026



4x
370226



1x
4177431



4x
370326



2x
4504382



4x
4548180



1x
4551168



1x
4295400



4x
4160393



5x
4180548



2x
302426



2x
302326

28

6x
302226



4x
362326



9x
302026



3x
4243819



1x
383226



1x
302926



3x
428226



2x
307026



2x
4550017



2x
4598528



2x
306926



5x
6020193



2x
4535739



1x
306826



65x
4121715

2x
4558170



4x
416226



1x
4603646



14x
403226



2x
4278359



1x
4537551



2x
4142822



2x
4128593



4x
6006140



4x
4107783



4x
4248204



10x
4140801



2x
370526



4x
370626



4x
370726

4

6

8



1x
4654448



4x
4211428

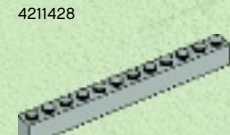

2x
4211522



5x
4211613



4x
4529241



1x
6020826



4x
4211526



8x
4651063



5x
4211527



1x
4211440



2x
4211614



2x
4211437



2x
4211436



4x
4211410

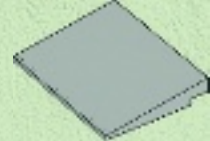

4x
4211819



1x
6042950



2x
4260935



1x
4212007



1x
4212008



2x
4260934



1x
4505088



1x
4505087



1x
4211451



6x
4211397



20x
4211353



2x
4211396



6x
4211445

4x
4640536



1x
4211510



8x
4211802



6x
6015347



3x
4211438



2x
4612621



1x
4243797



1x
4211452



8x
4211425



1x
4211407



4x
4507052





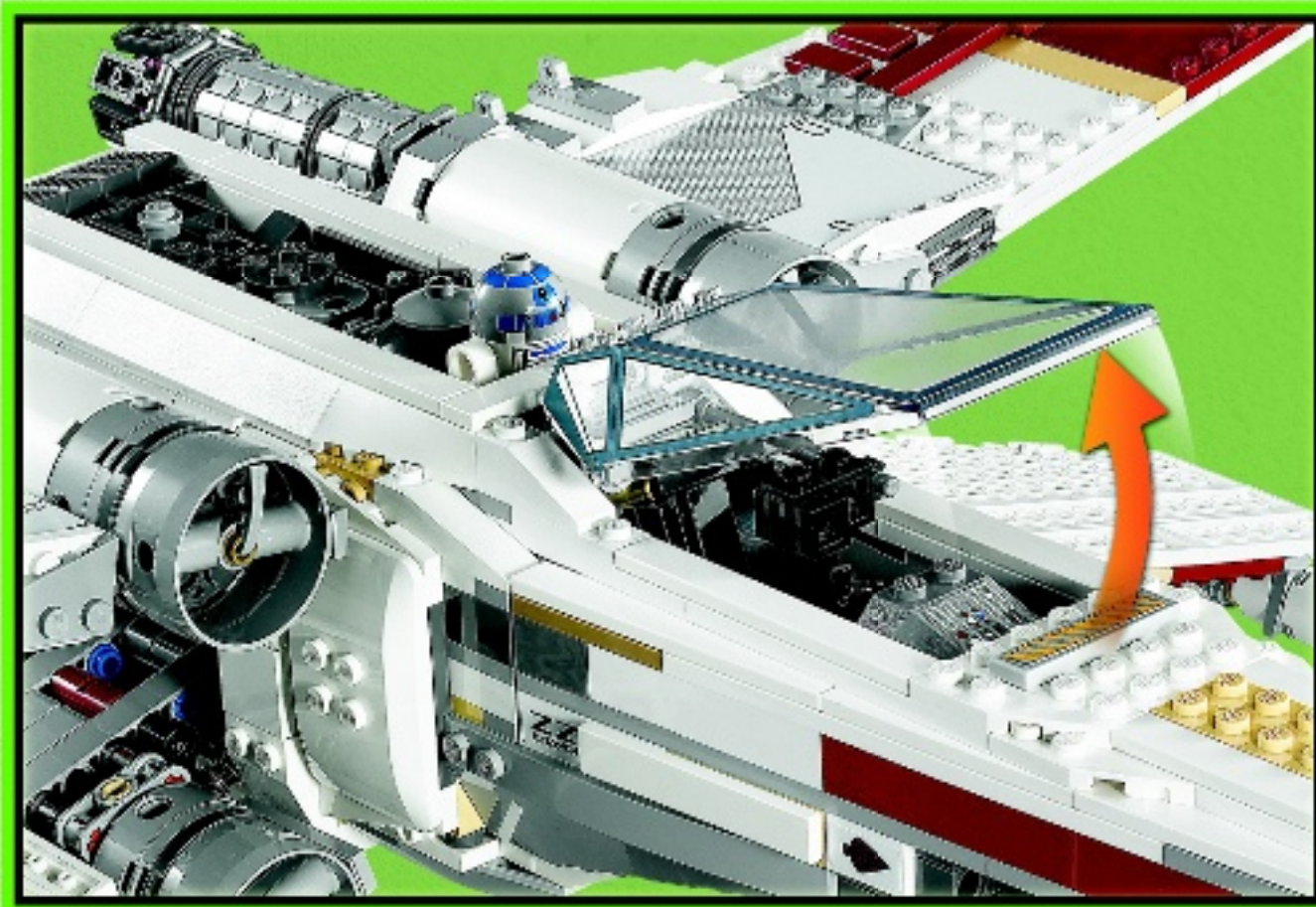

Customer Service
Kundenservice
Service Consommateurs
Servicio Al Consumidor
LEGO.com/service or dial

: 00800 5346 5555
: 1-800-422-5346

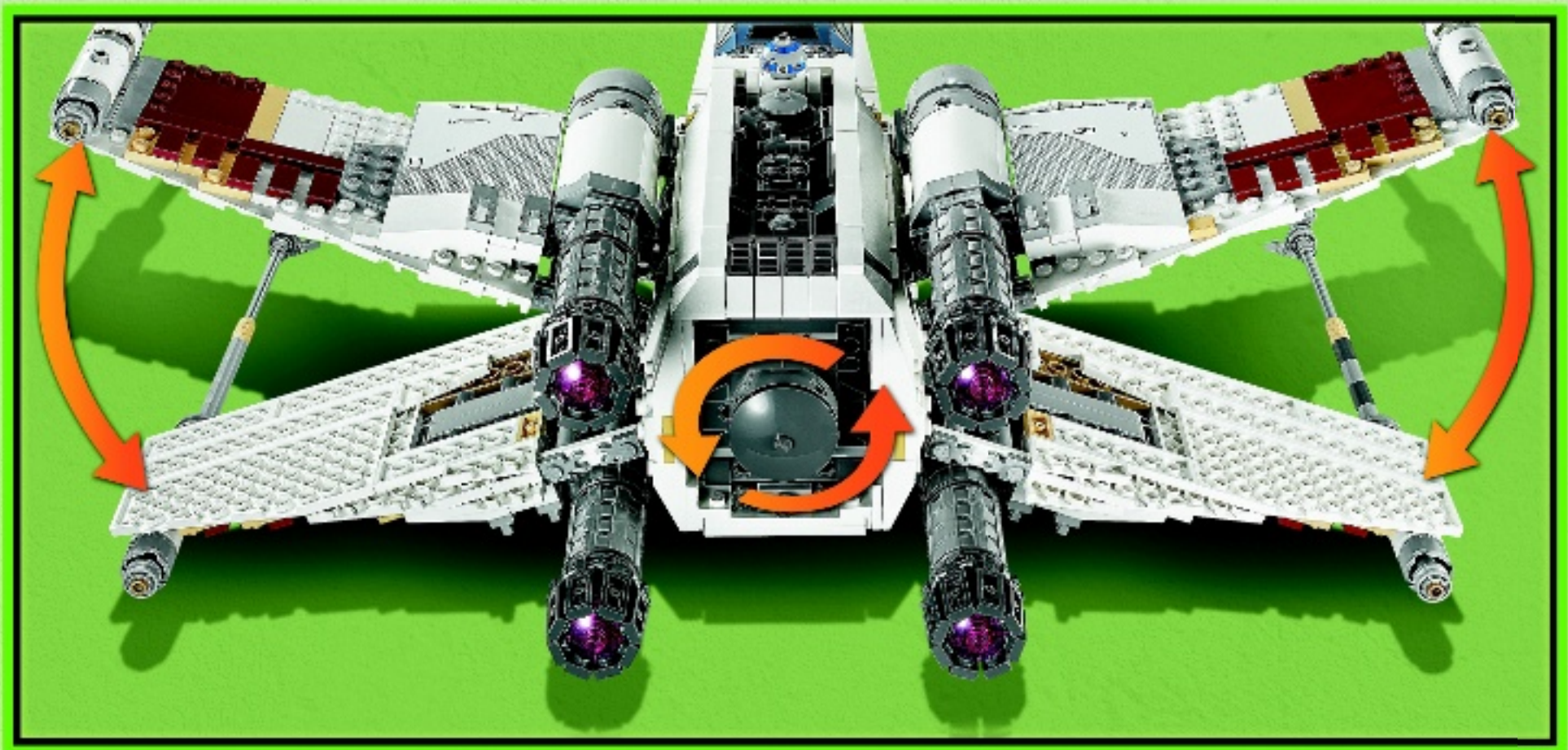





WIN!

Go to www.LEGOsurvey.com/product to fill out a survey for a chance to win a cool LEGO® Product.

No purchase necessary.

Open to all residents where not prohibited.



www.LEGOsurvey.com/product

GEWINNE!

Nimm an der Umfrage auf www.LEGOsurvey.com/product teil und hab die Chance ein cooles LEGO® Produkt zu gewinnen!

Die Teilnahme am Gewinnspiel führt zu keinerlei Kaufverpflichtungen. Teilnahme in allen nicht ausgeschlossenen Ländern möglich.

WIN!

Ga naar www.LEGOsurvey.com/product, vul een enquêteformulier in en maak kans op een cool LEGO® product.

Geen aankoopverplichting. Iedereen mag deelnemen, uitgezonderd ingezetenden van landen waar een enquêteverbod geldt.

GAGNE!

Visite www.LEGOsurvey.com/product pour répondre à un questionnaire et avoir une chance de gagner un produit LEGO® très cool!

Aucune obligation d'achat. Ouvert à tous les résidents des pays autorisés.

当てよう!

www.LEGOsurvey.com/product にアクセスして、アンケートにご記入ください。当選者にはレゴ製品を差し上げます。

お買い上げの必要はありません。禁止されていない限り、すべての皆様にご利用いただけます。