



# CREATOR

10241



**EXPERT**

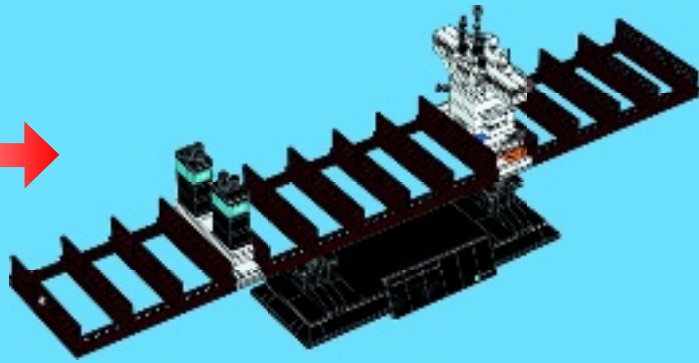

8x

80

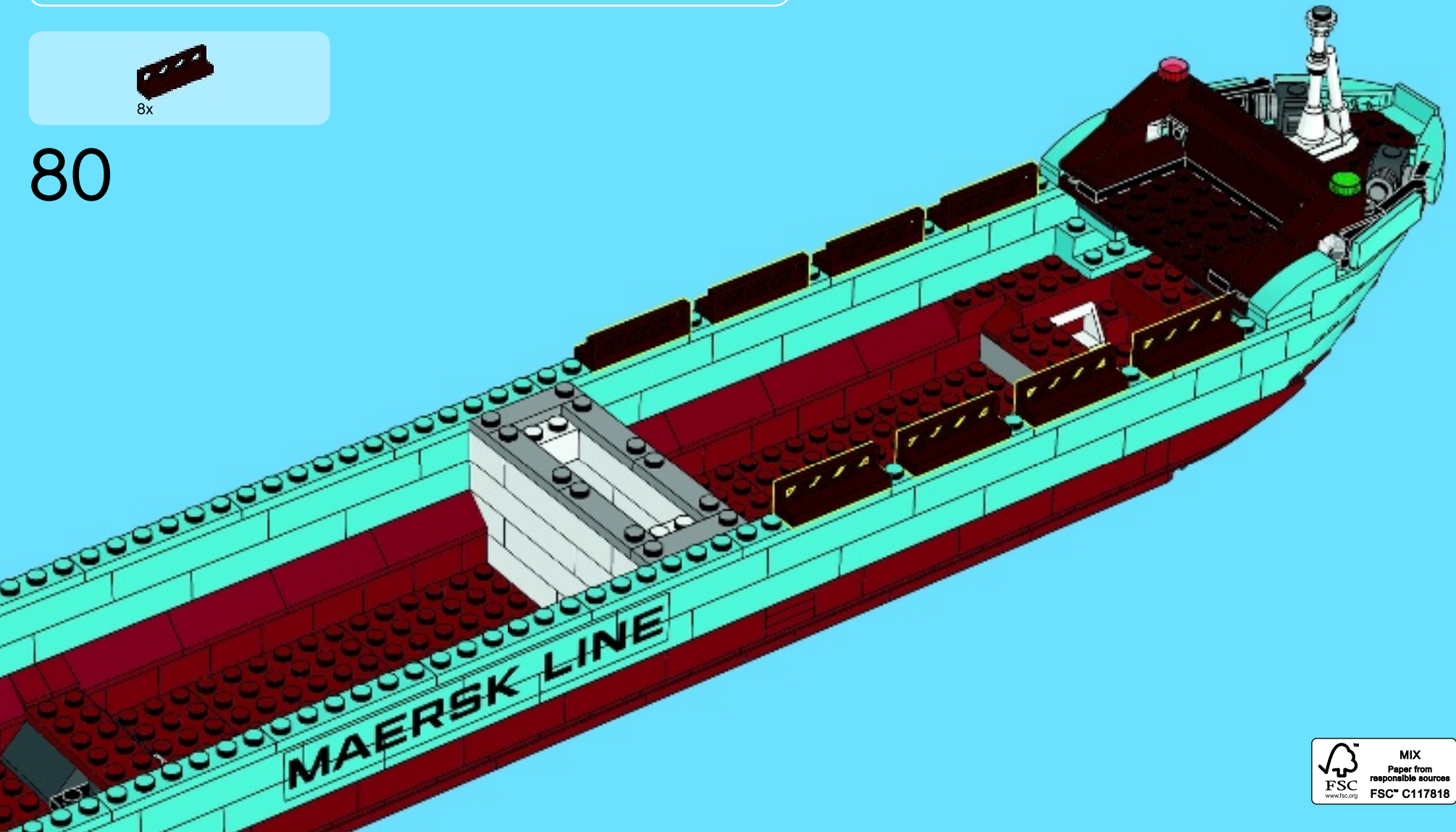



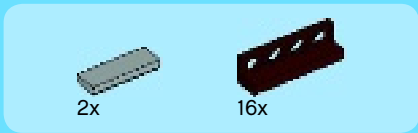

81

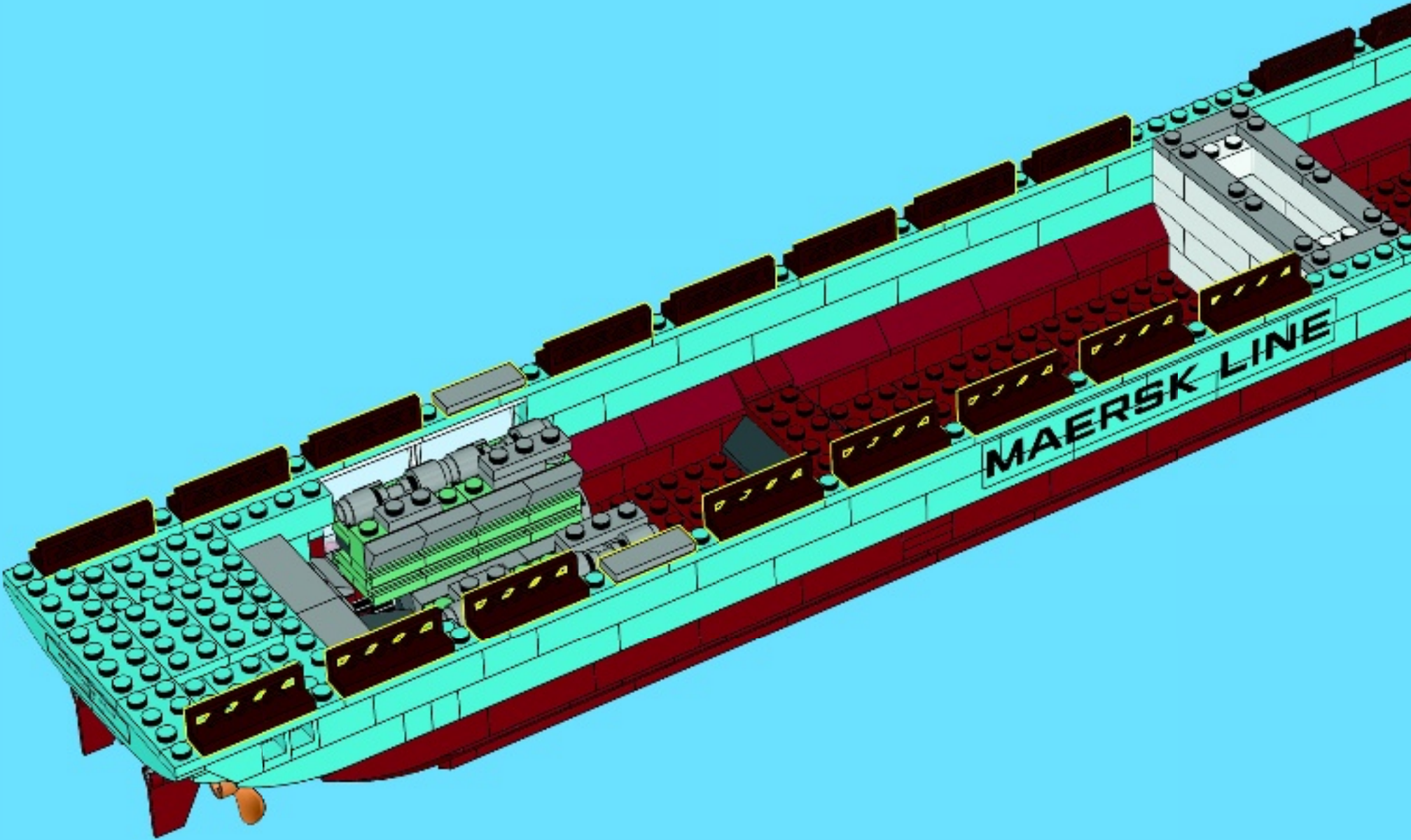

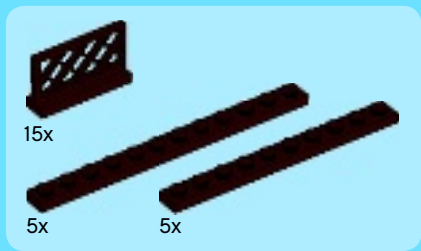

82

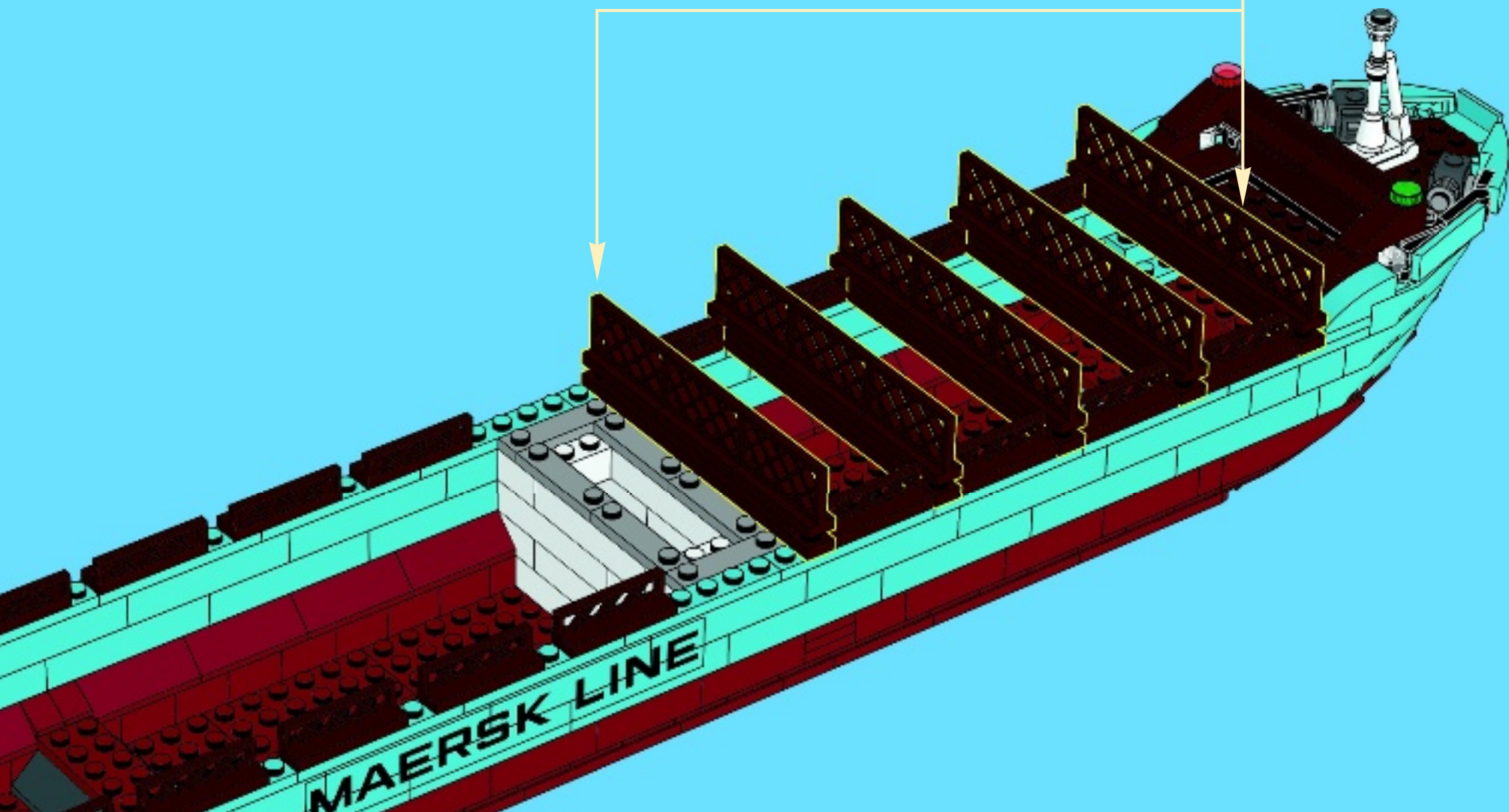
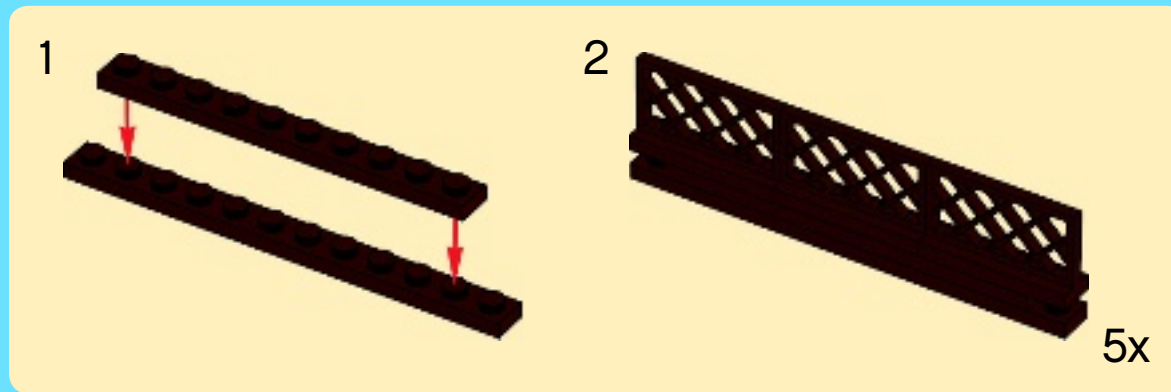



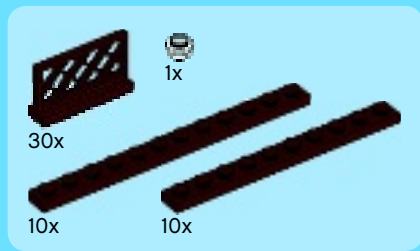

83

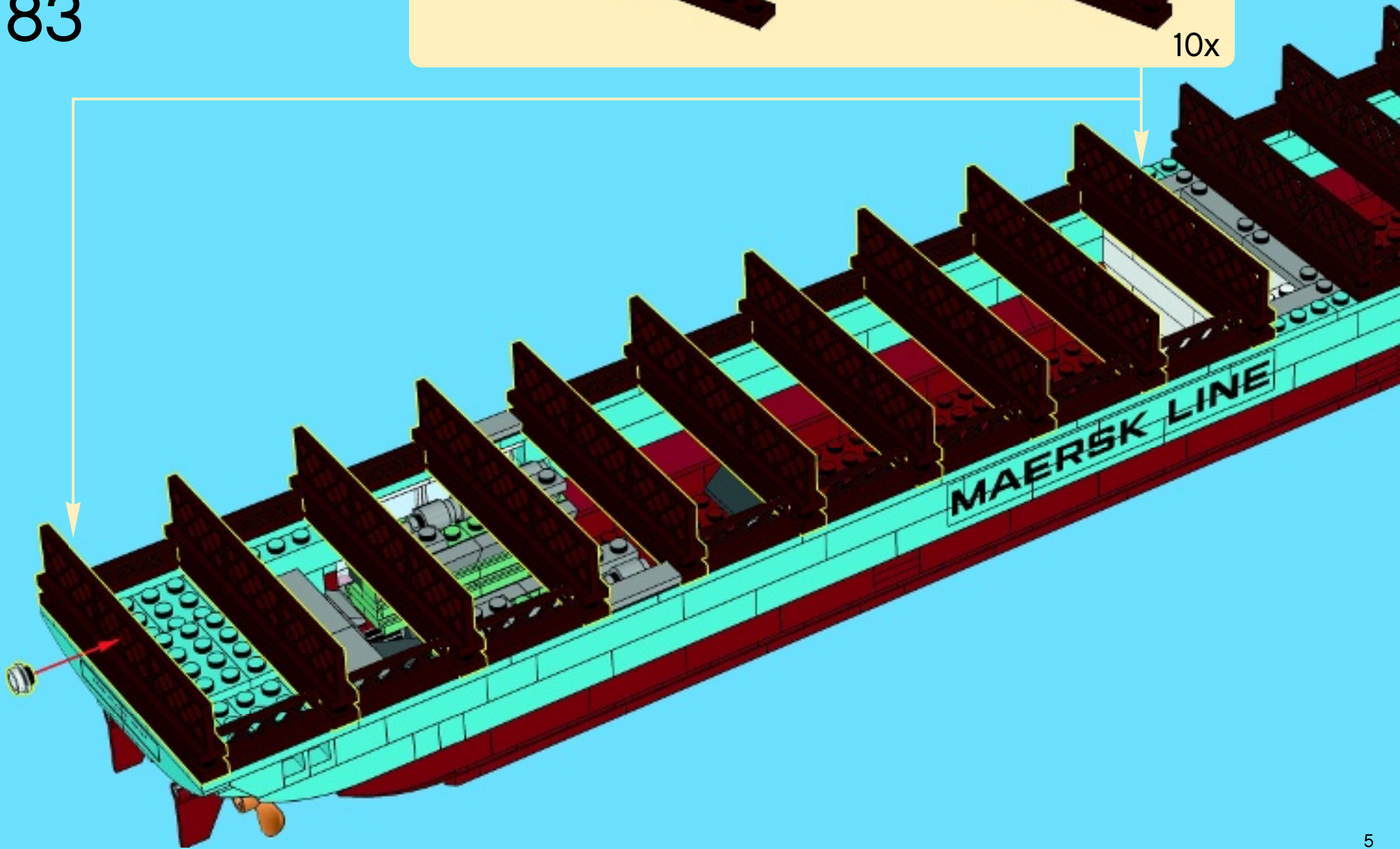
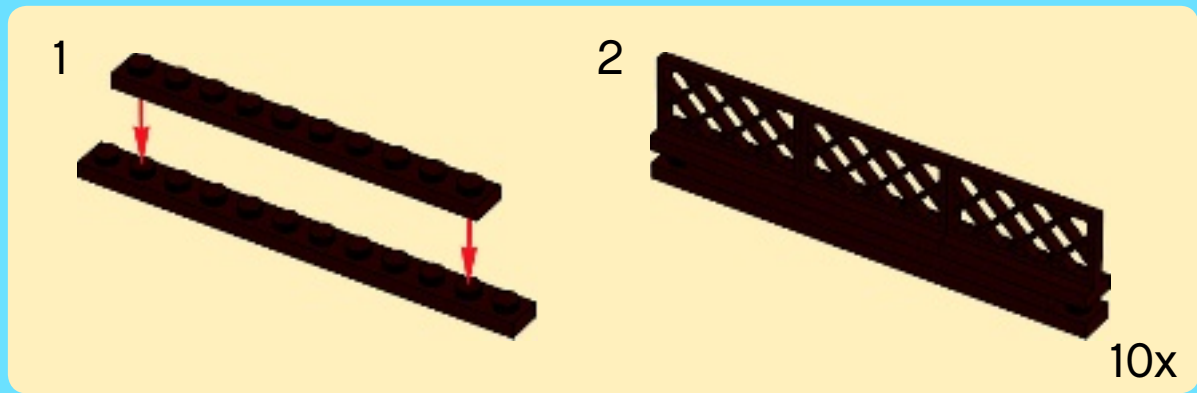

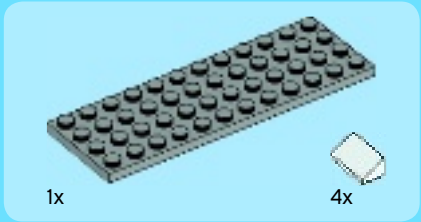
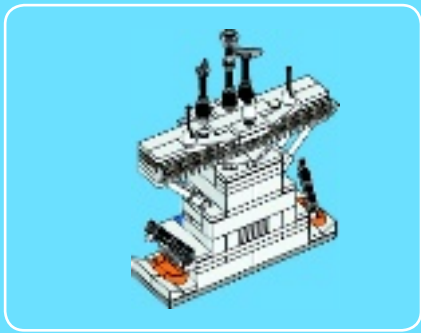

1

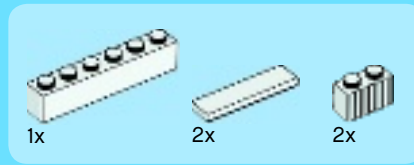
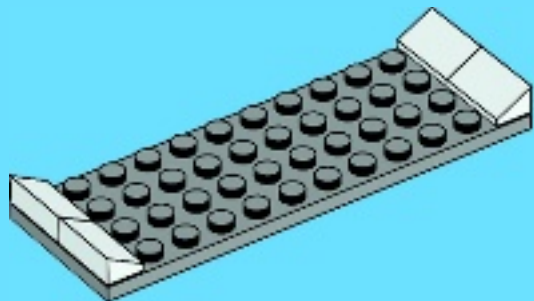

2

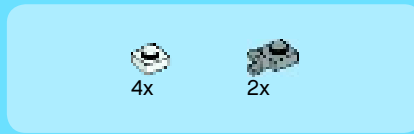
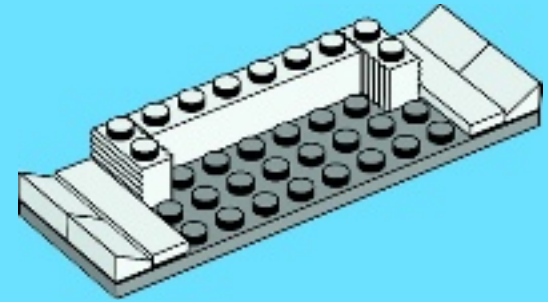

3

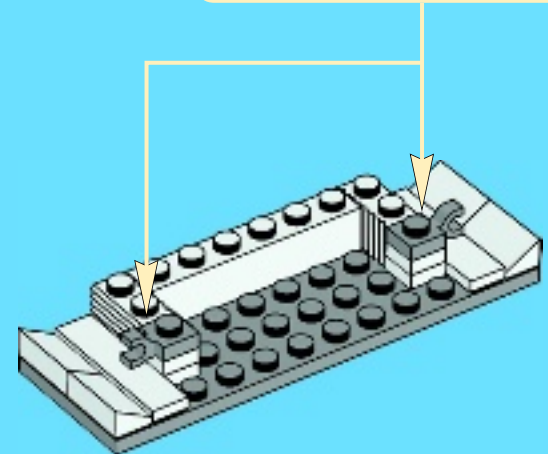
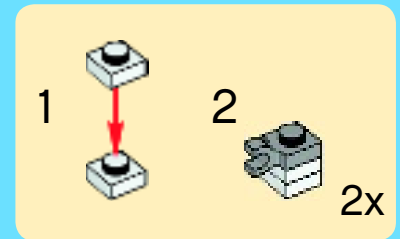





2x

4

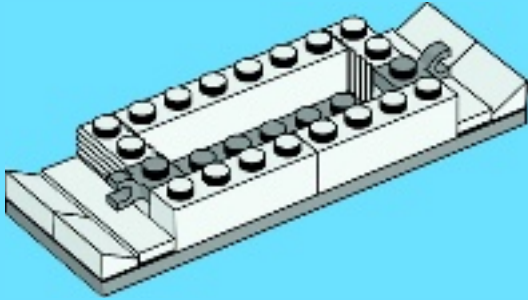

2x



2x



2x

5

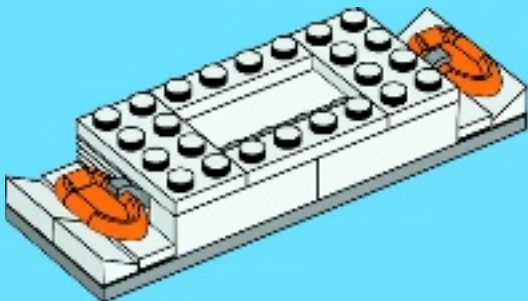

2x



2x



1x



2x



1x

6

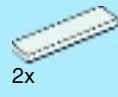
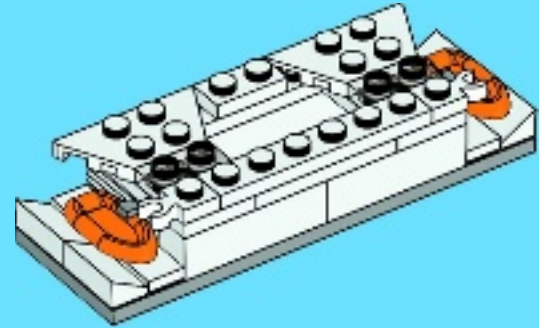

2x



1x



1x

7

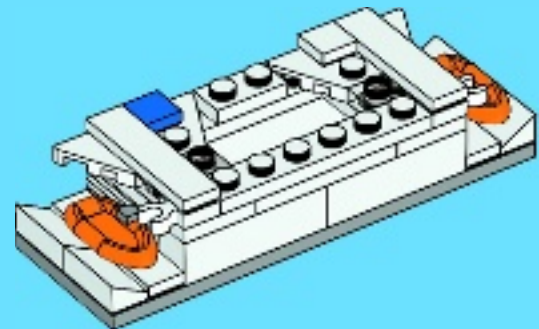

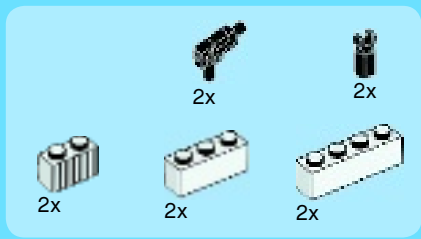

8

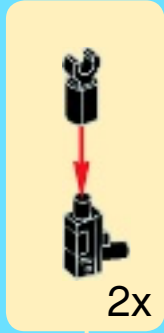

2x

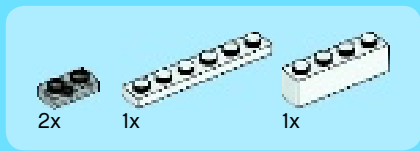
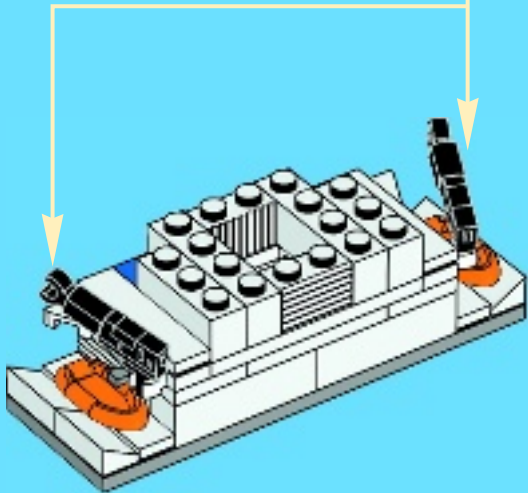

9

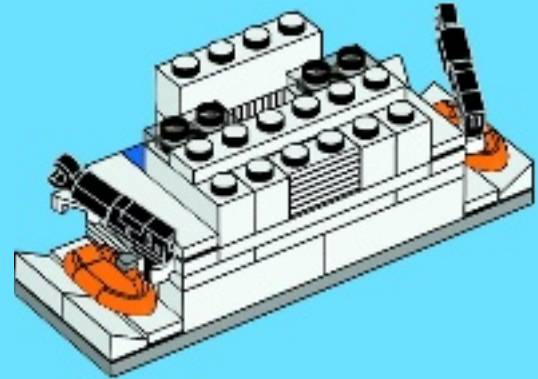

10

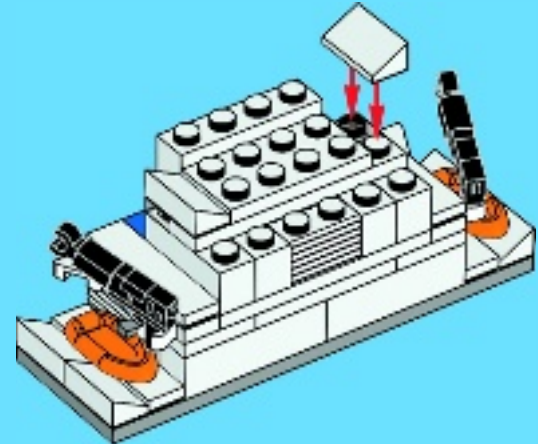



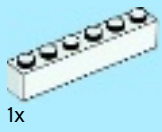

1x



1x

# 11

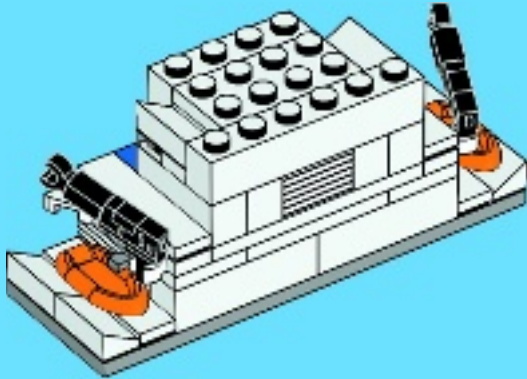

2x



2x



4x

# 12

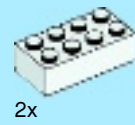
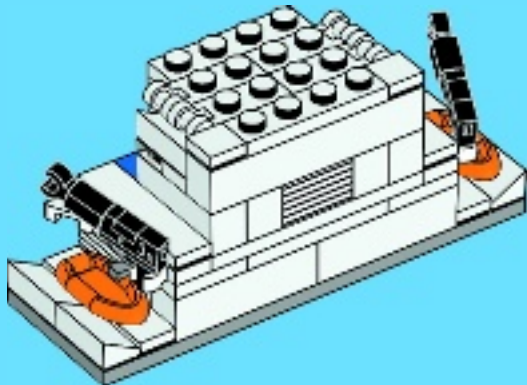

2x



4x



4x

# 13

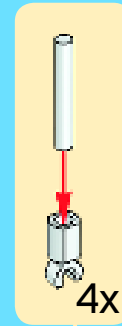

4x

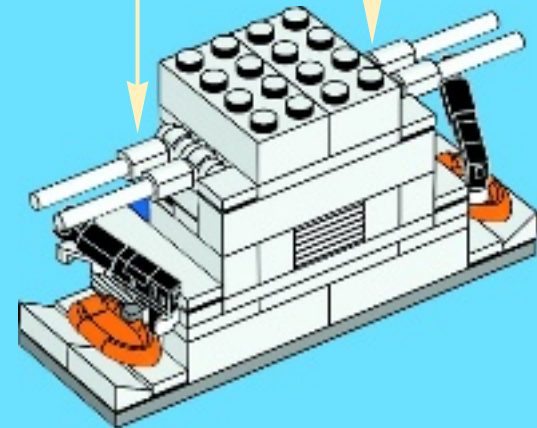

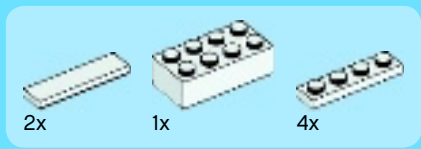

14

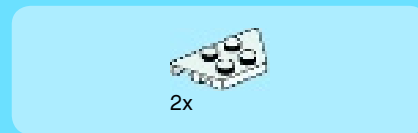
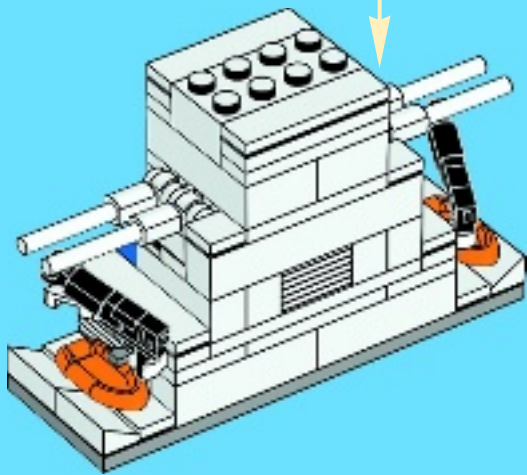
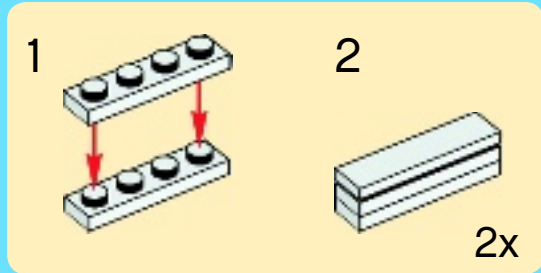

15

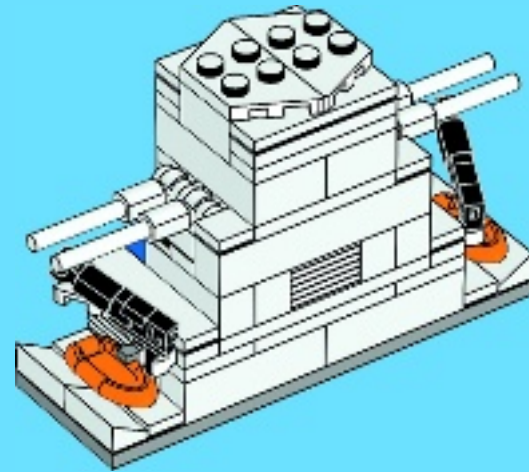



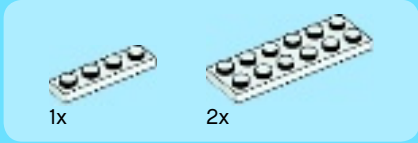
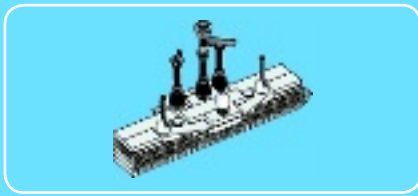

1

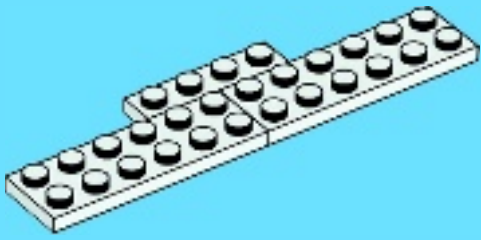

2

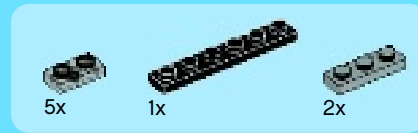
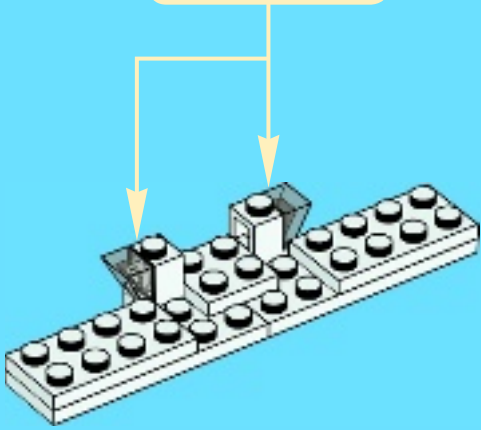
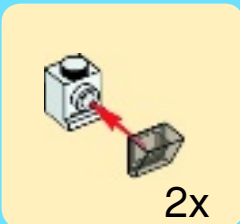

3

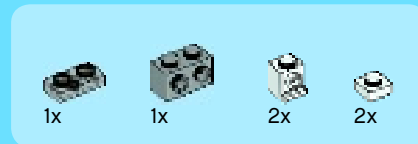
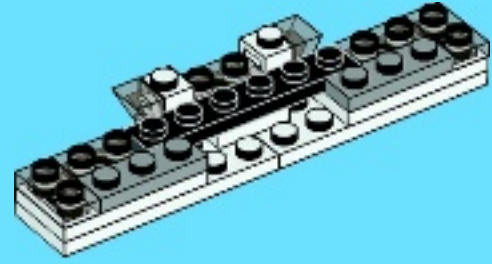

4

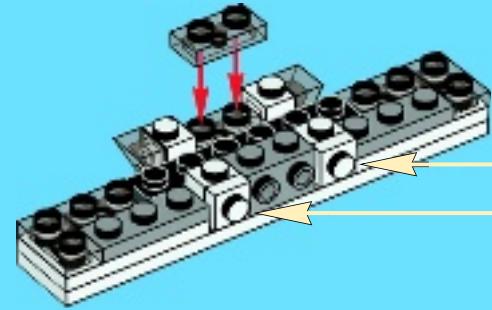
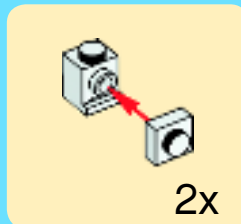

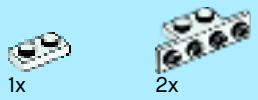

5

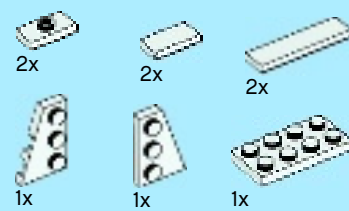
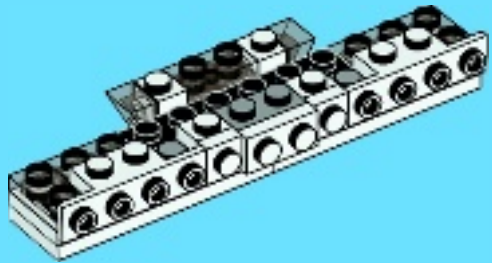

7

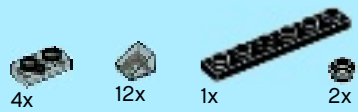
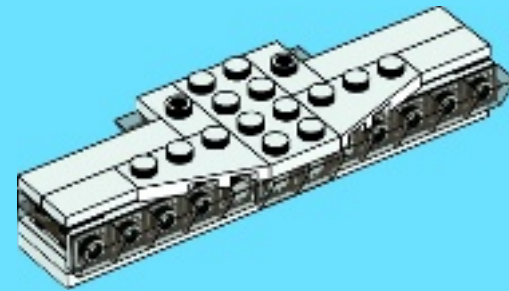

6



8

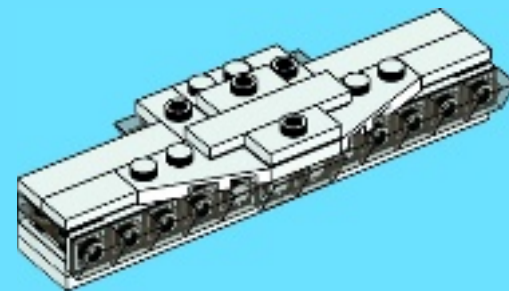

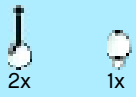

9

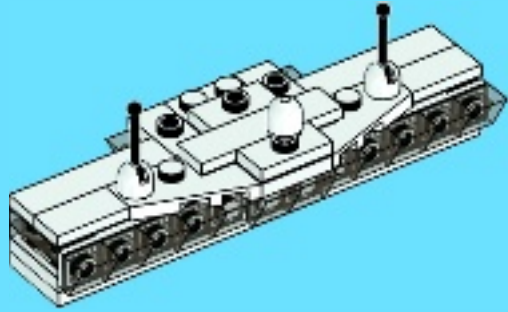

11

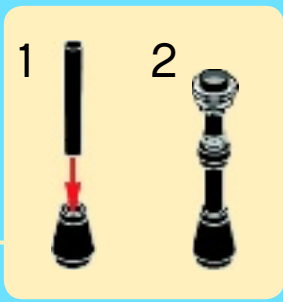
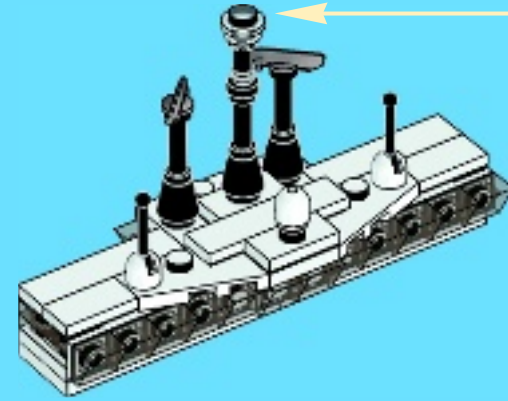

10

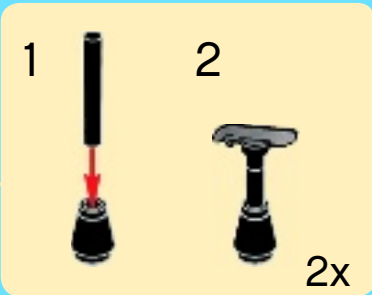
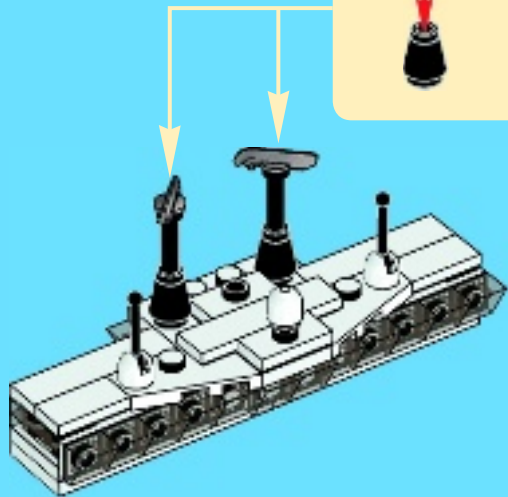

16

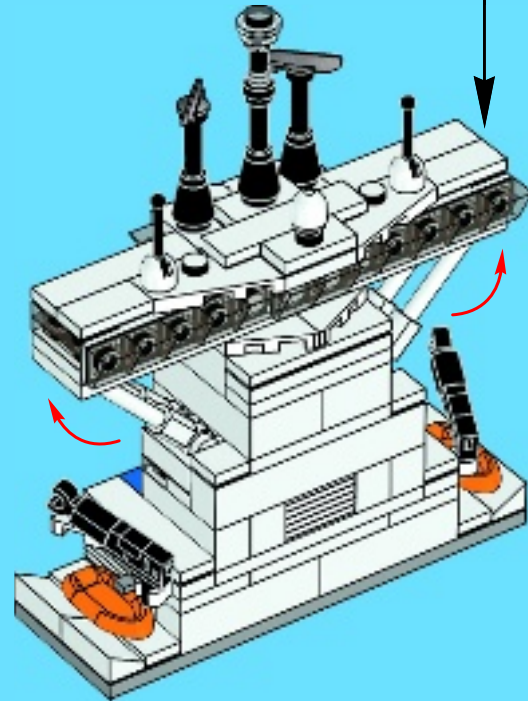



84



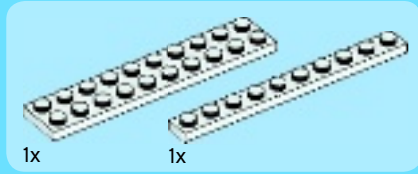
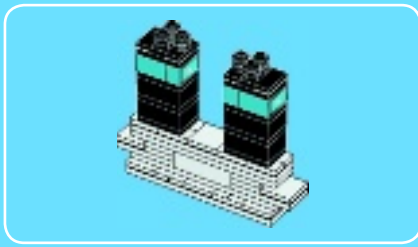

1

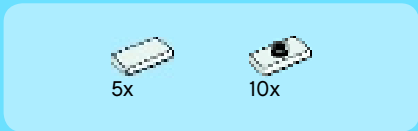
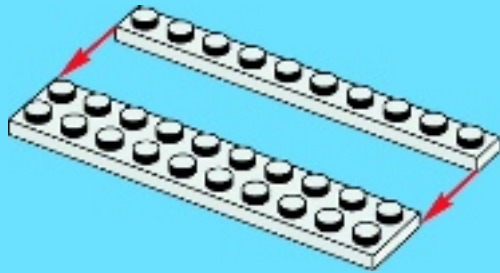

2

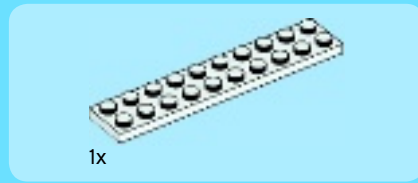
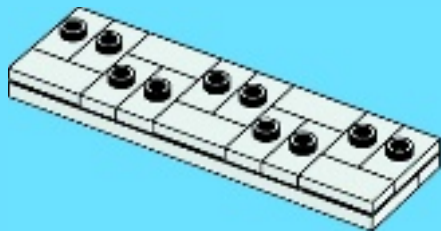

3

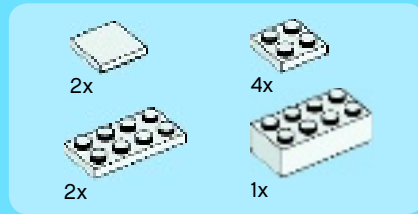
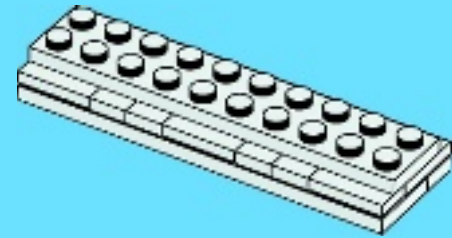

4

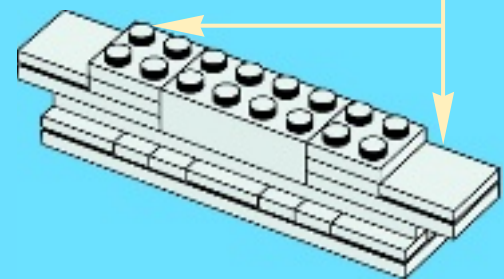
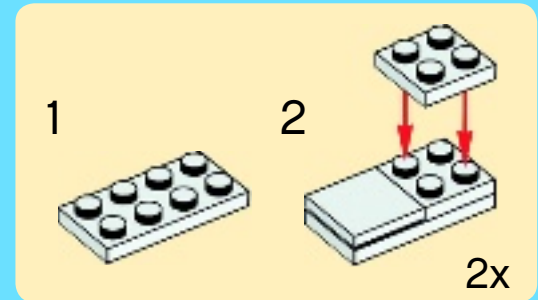
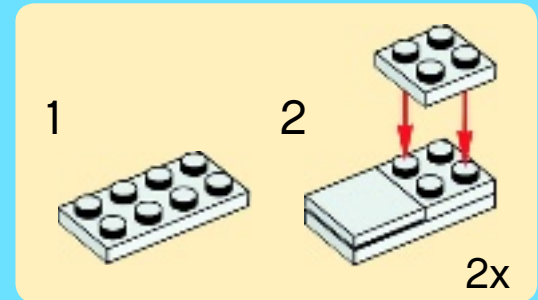

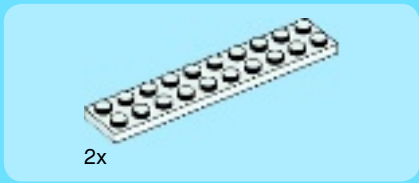

5

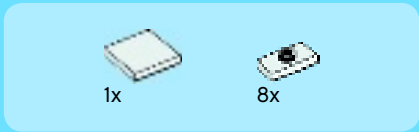
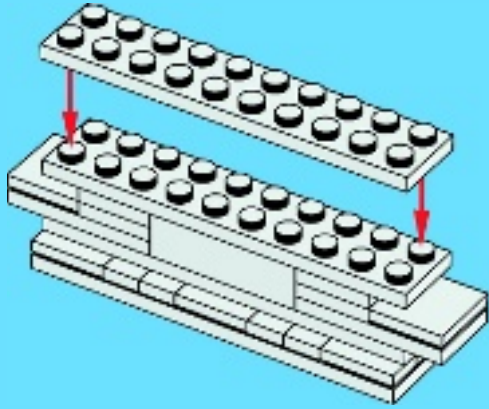

6

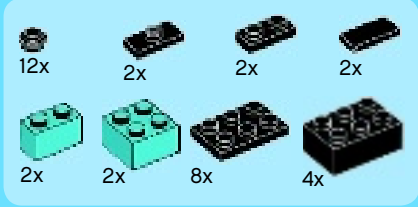
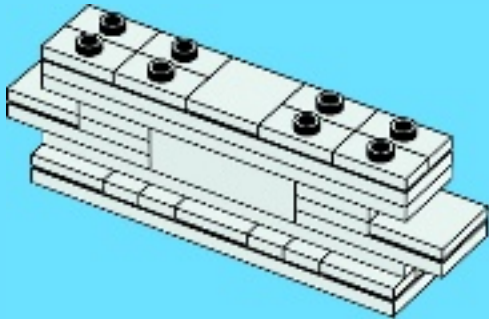

7

1

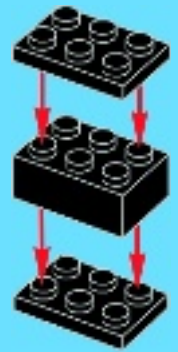

2

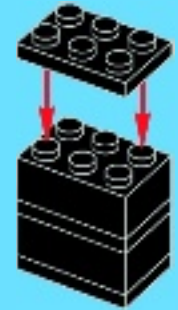



3

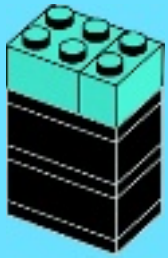

4

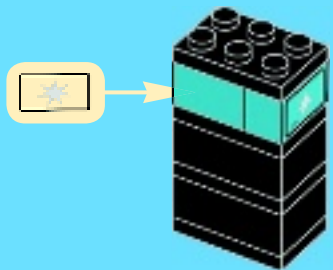

5

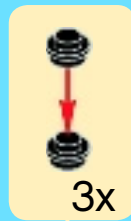

6



2x

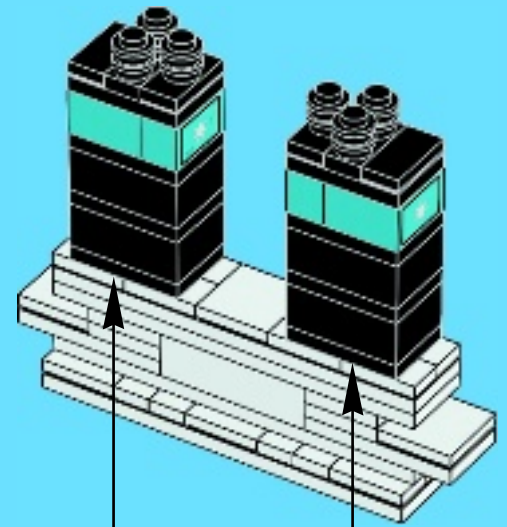

85

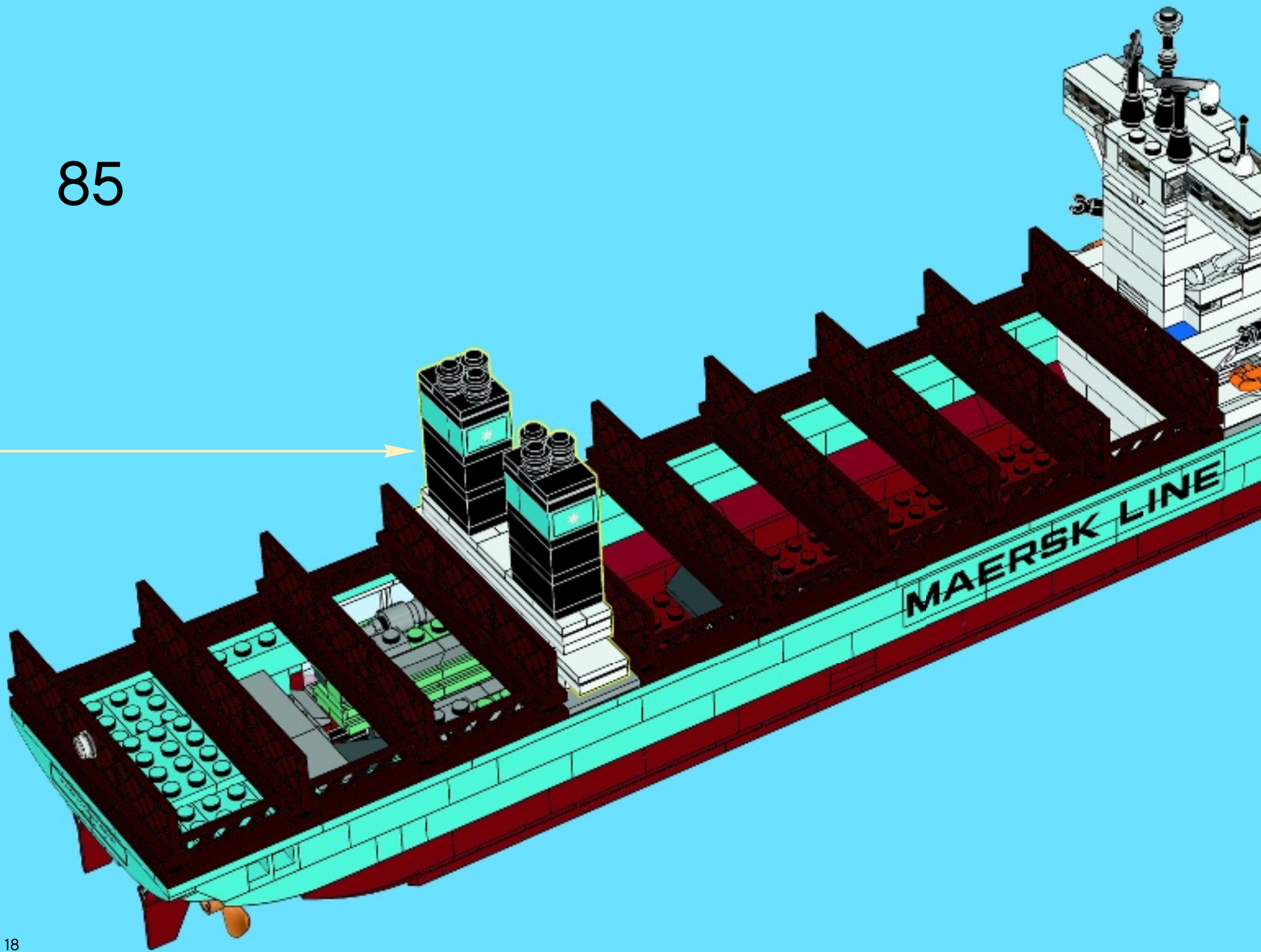

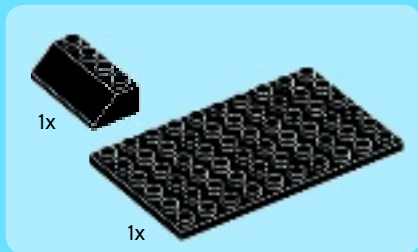
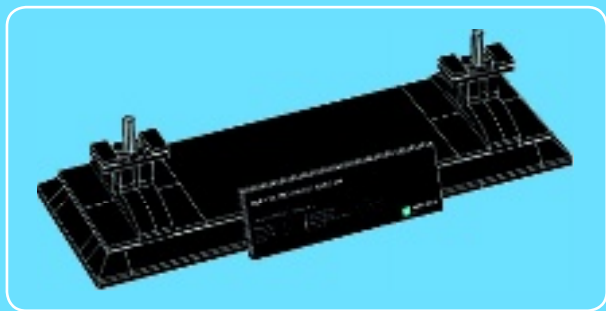

1



2



3

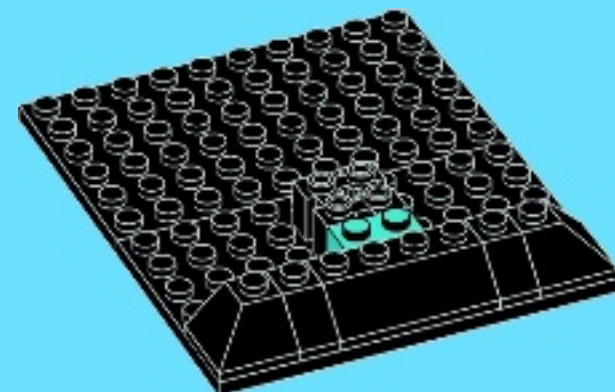



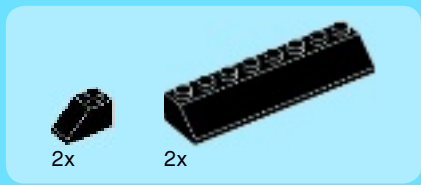

4

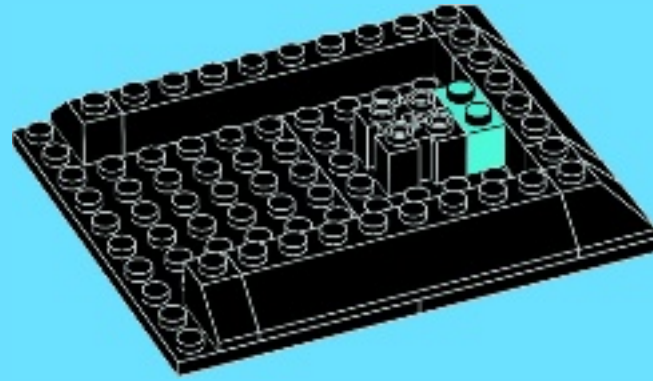

5

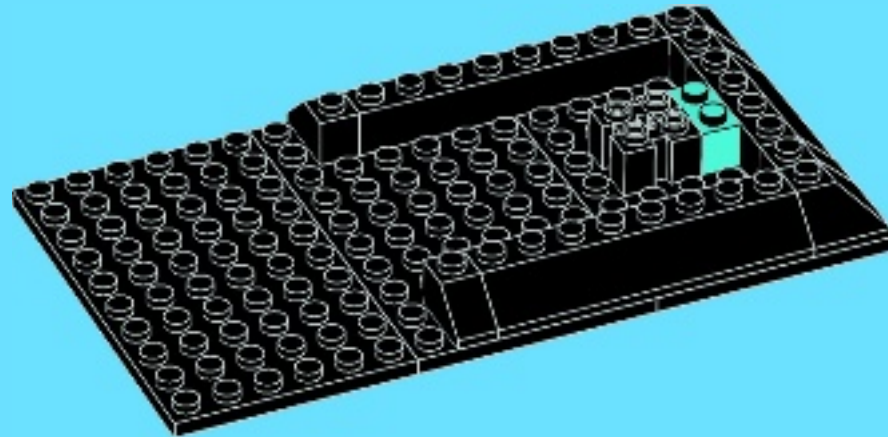

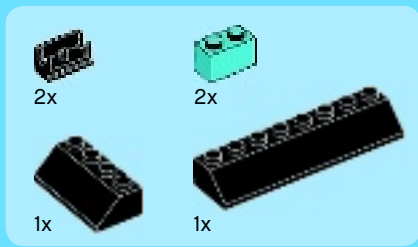

6

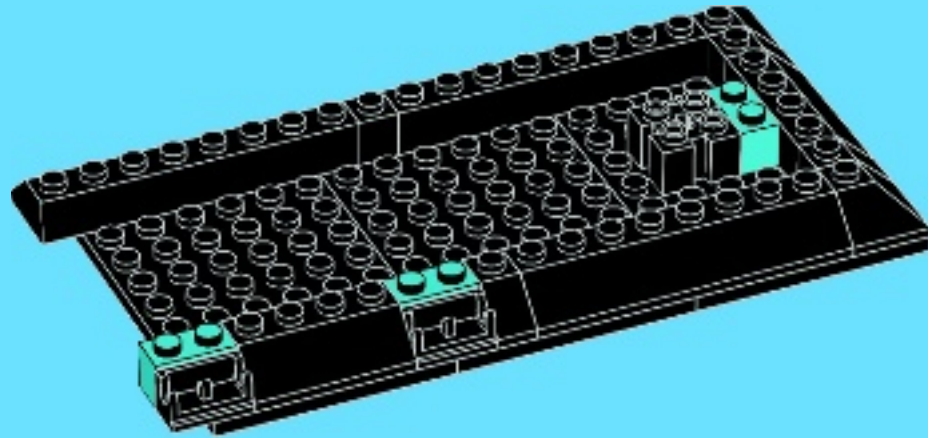

7

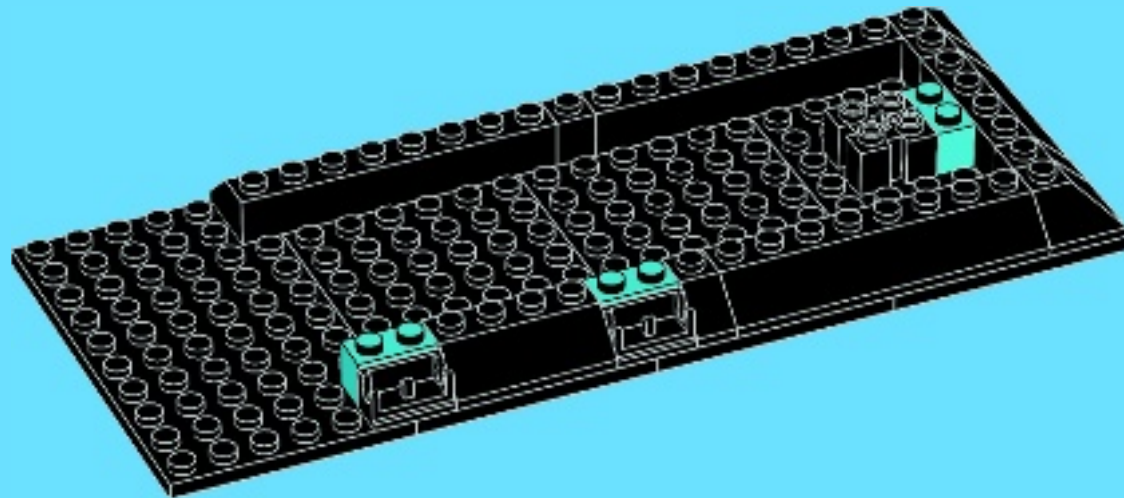



8

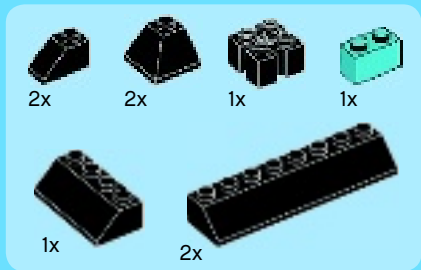
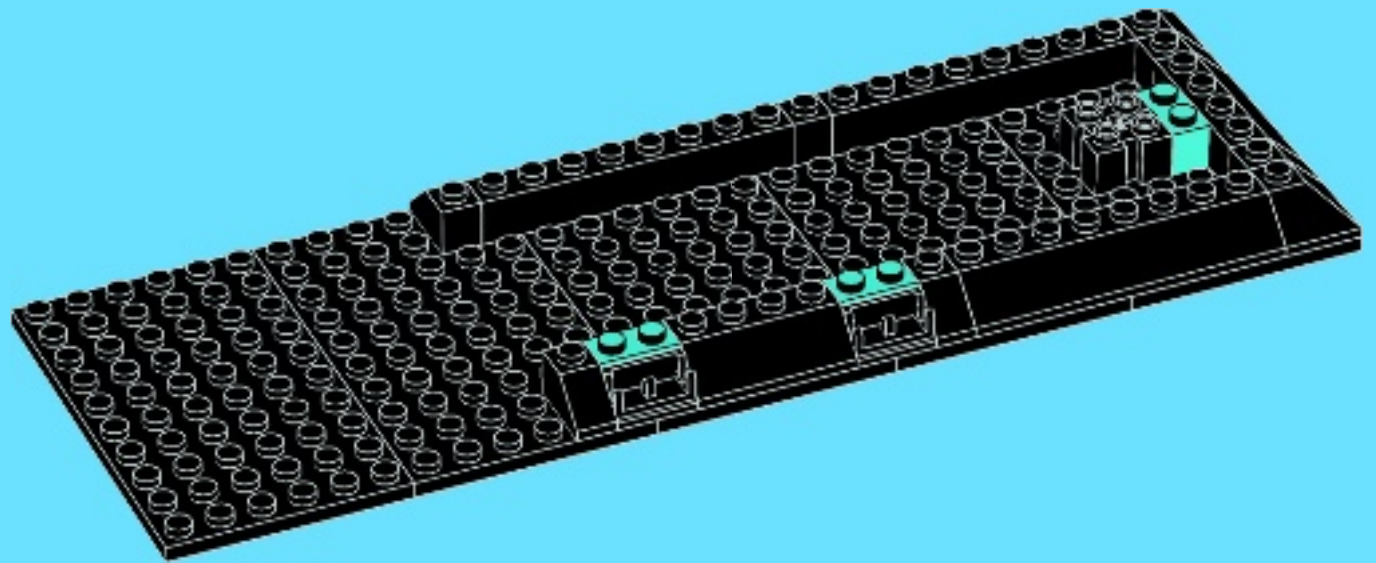

9

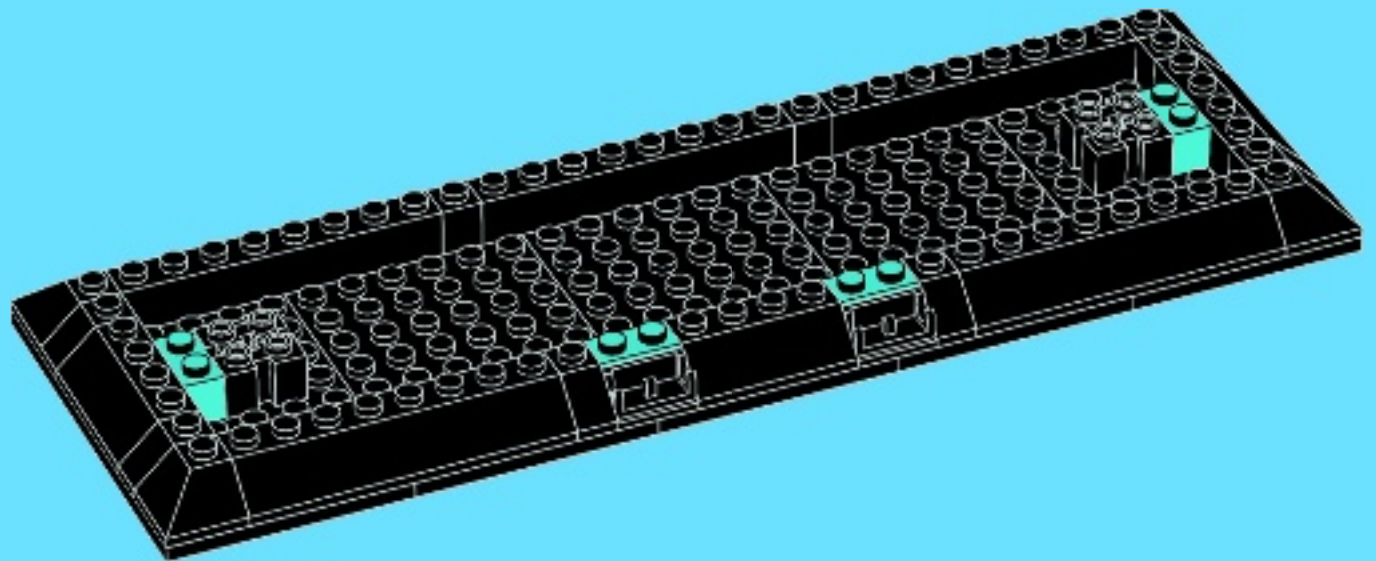



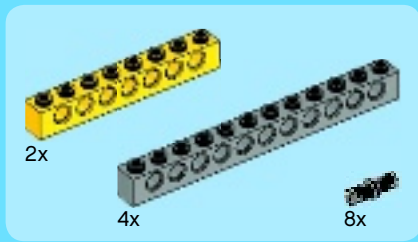

10

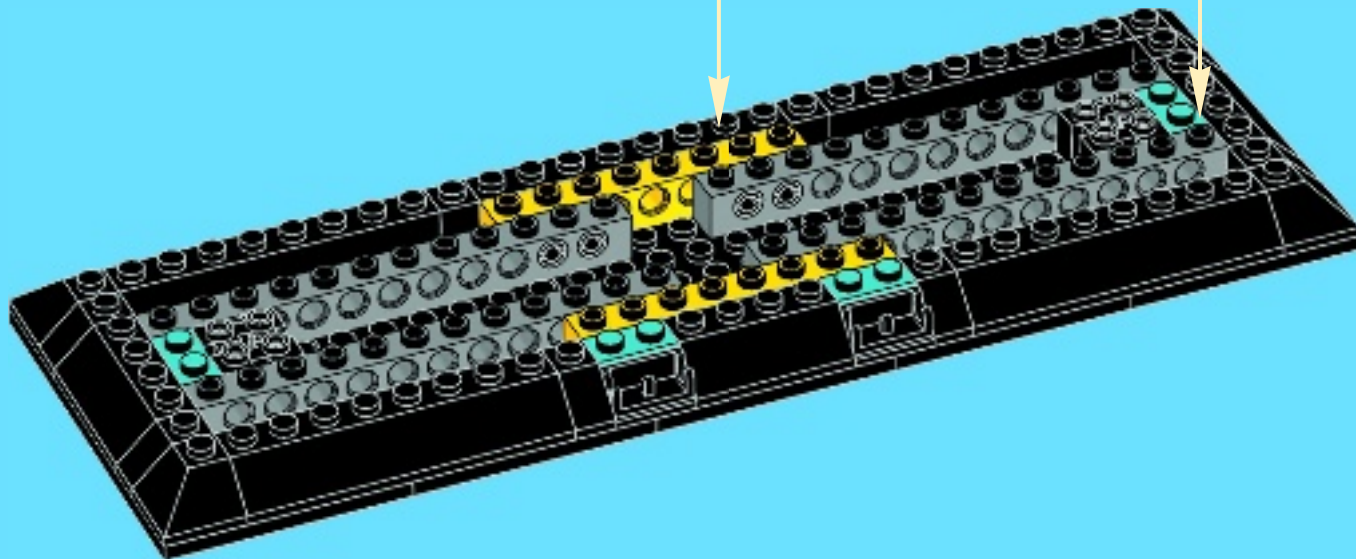
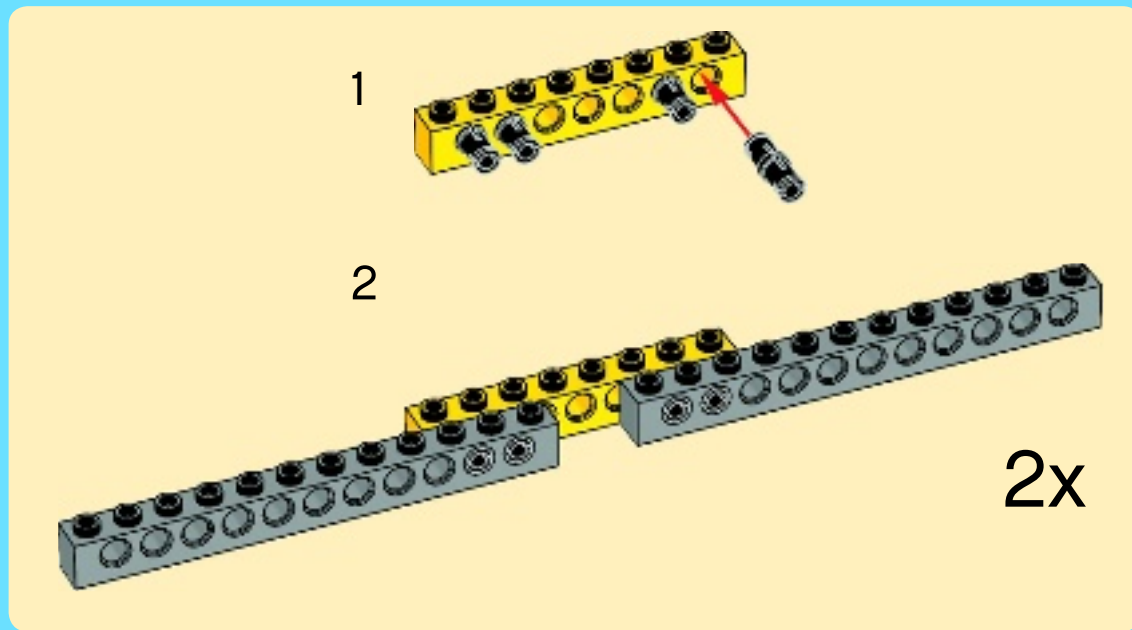

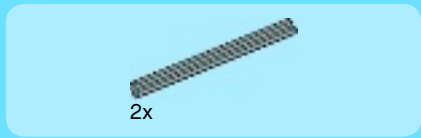

11

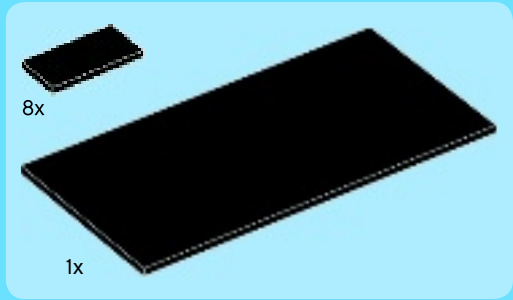
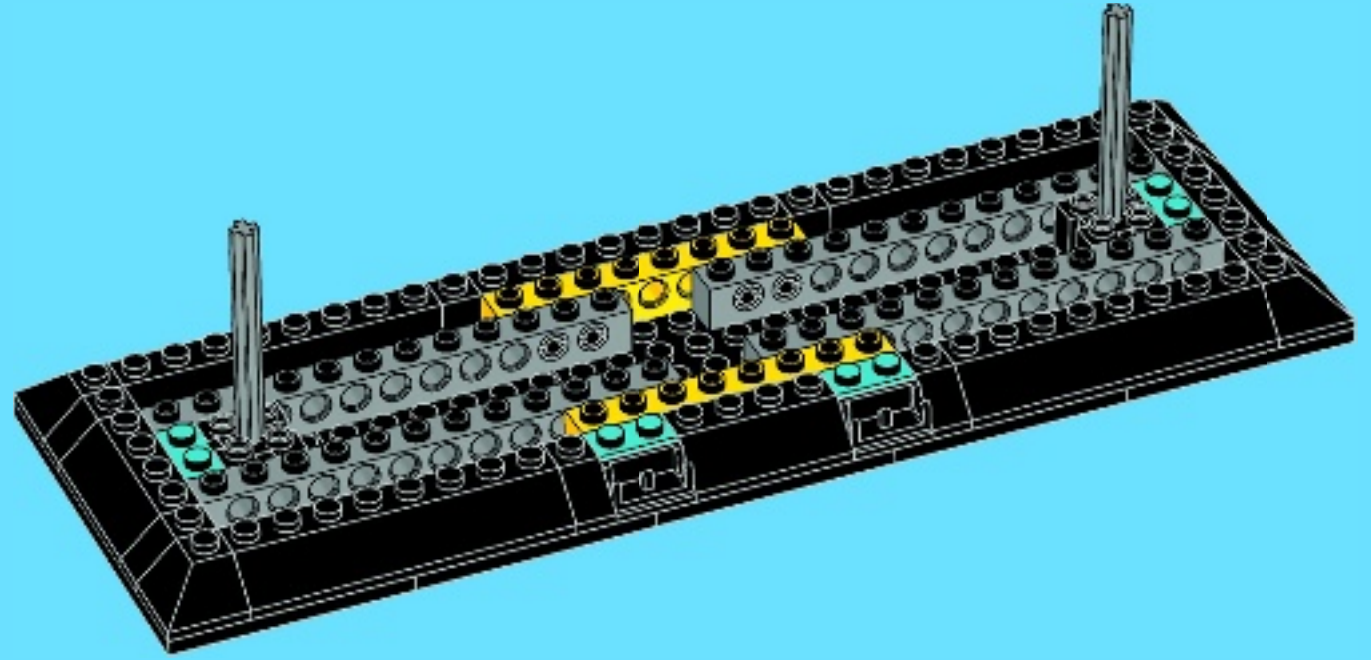

12

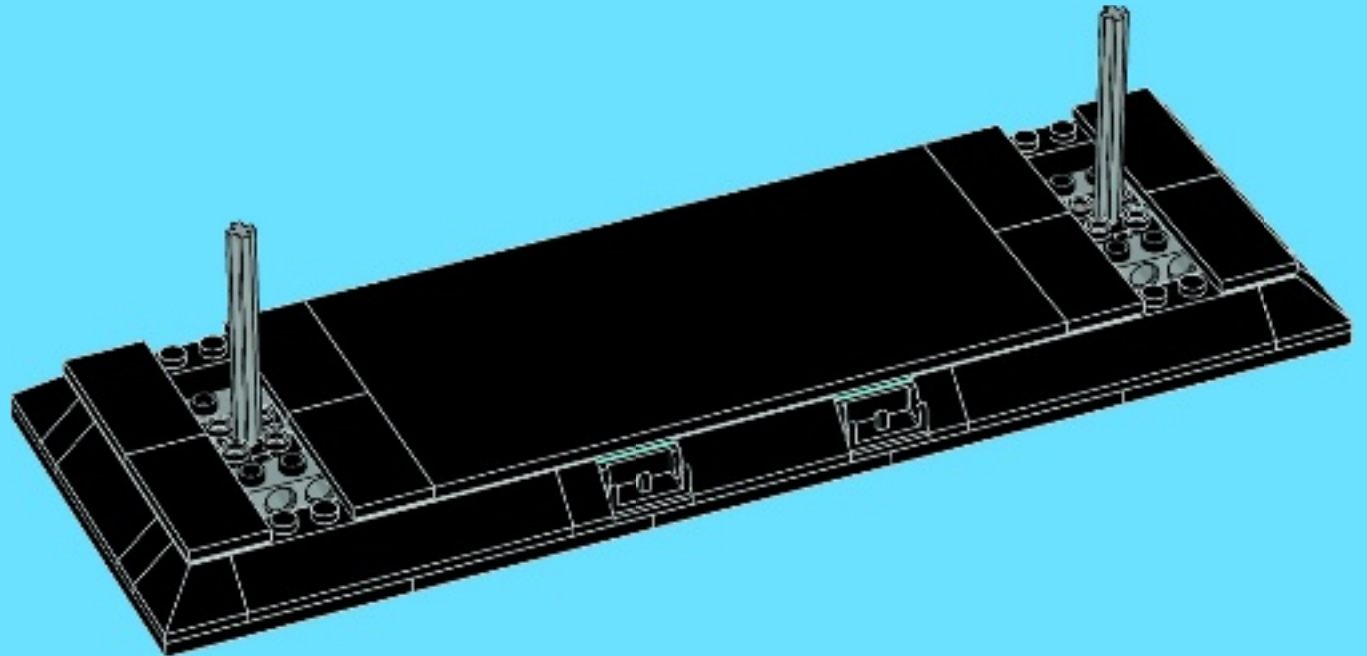

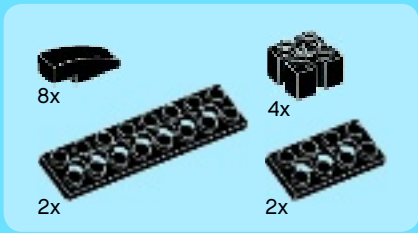

13

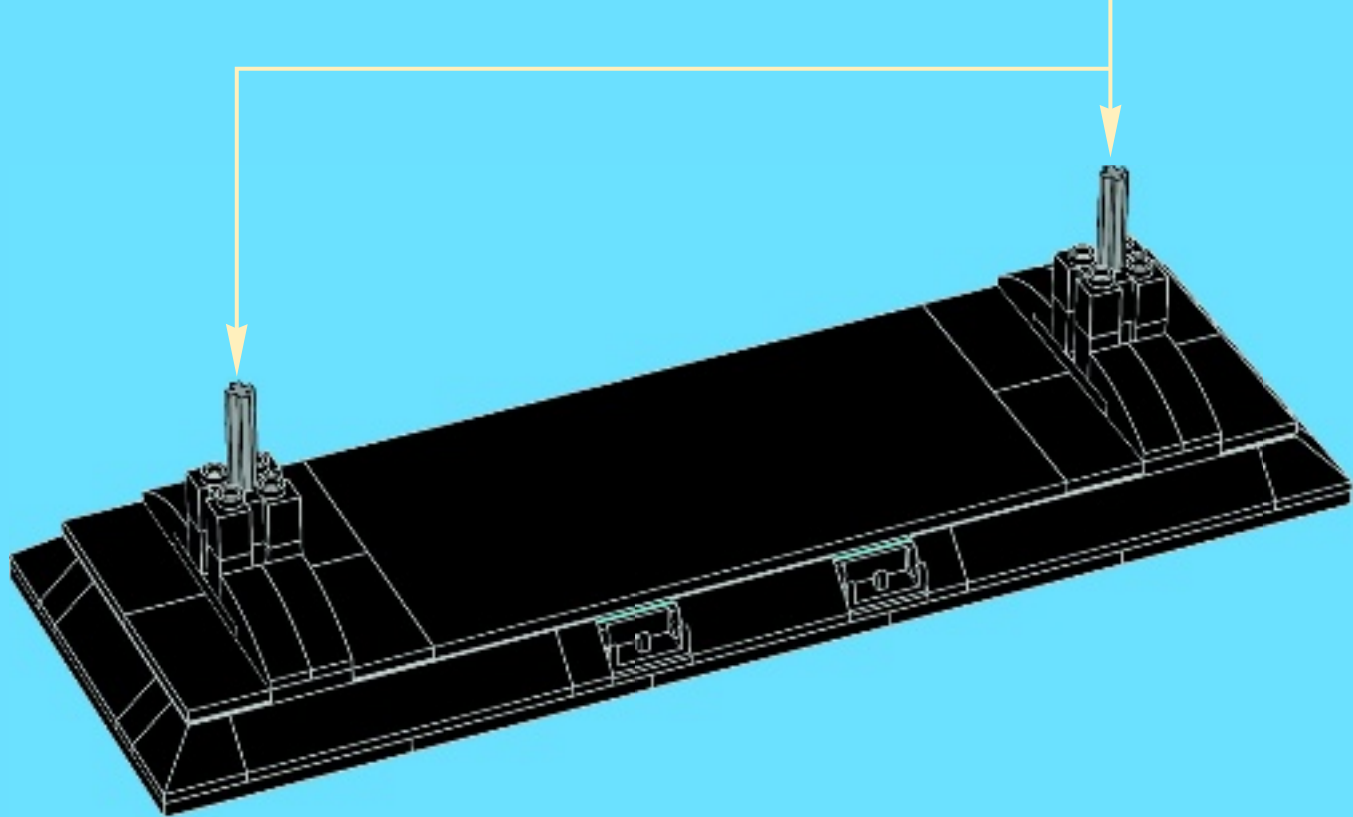
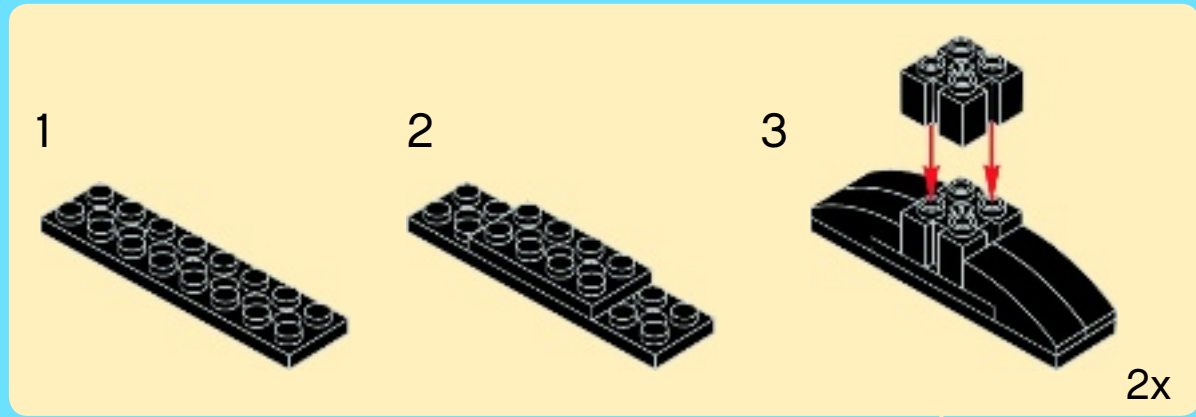





14

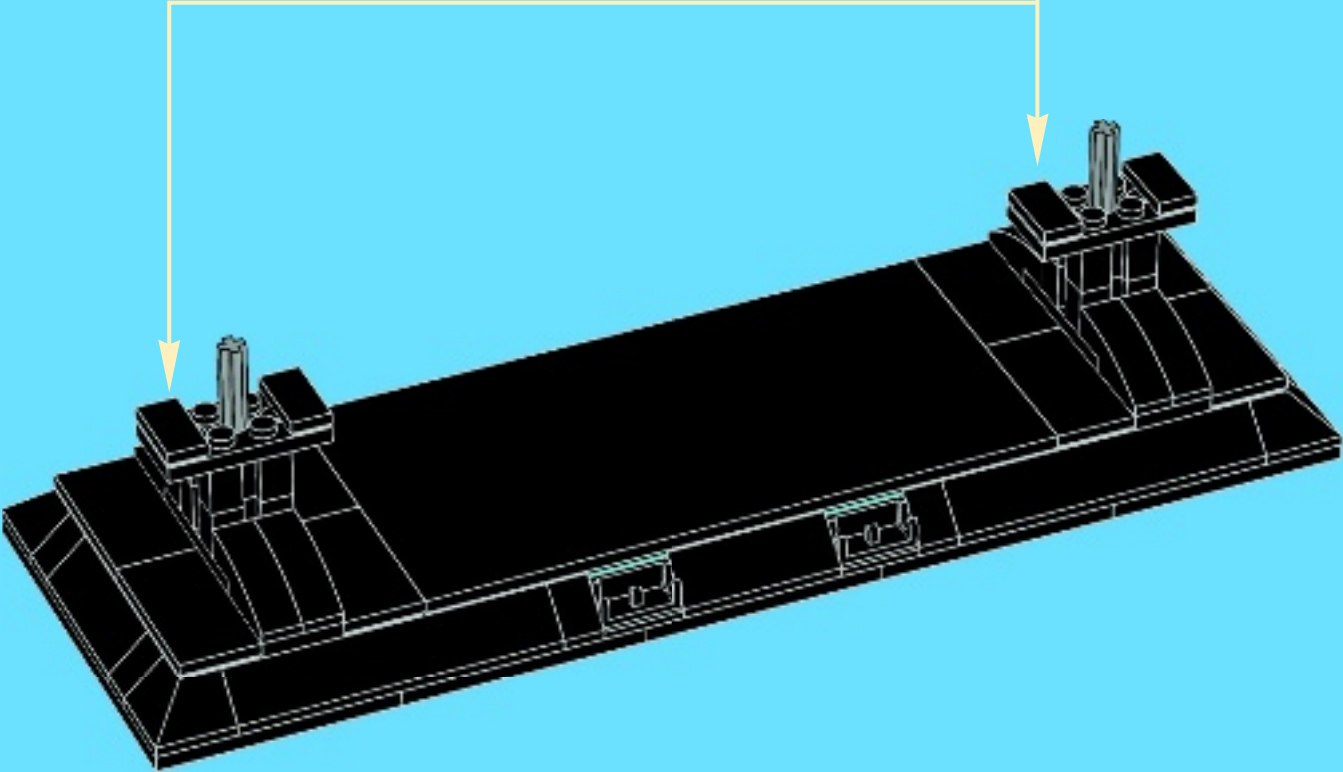
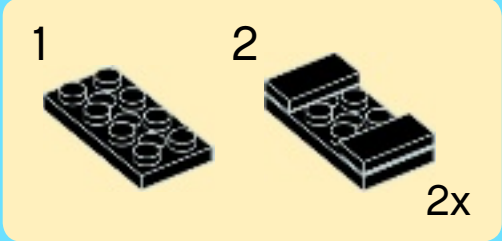

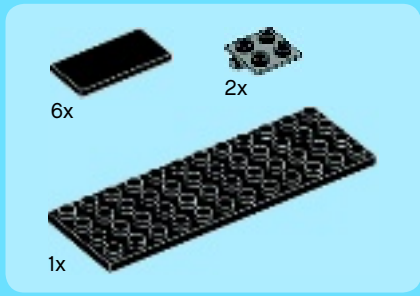

15

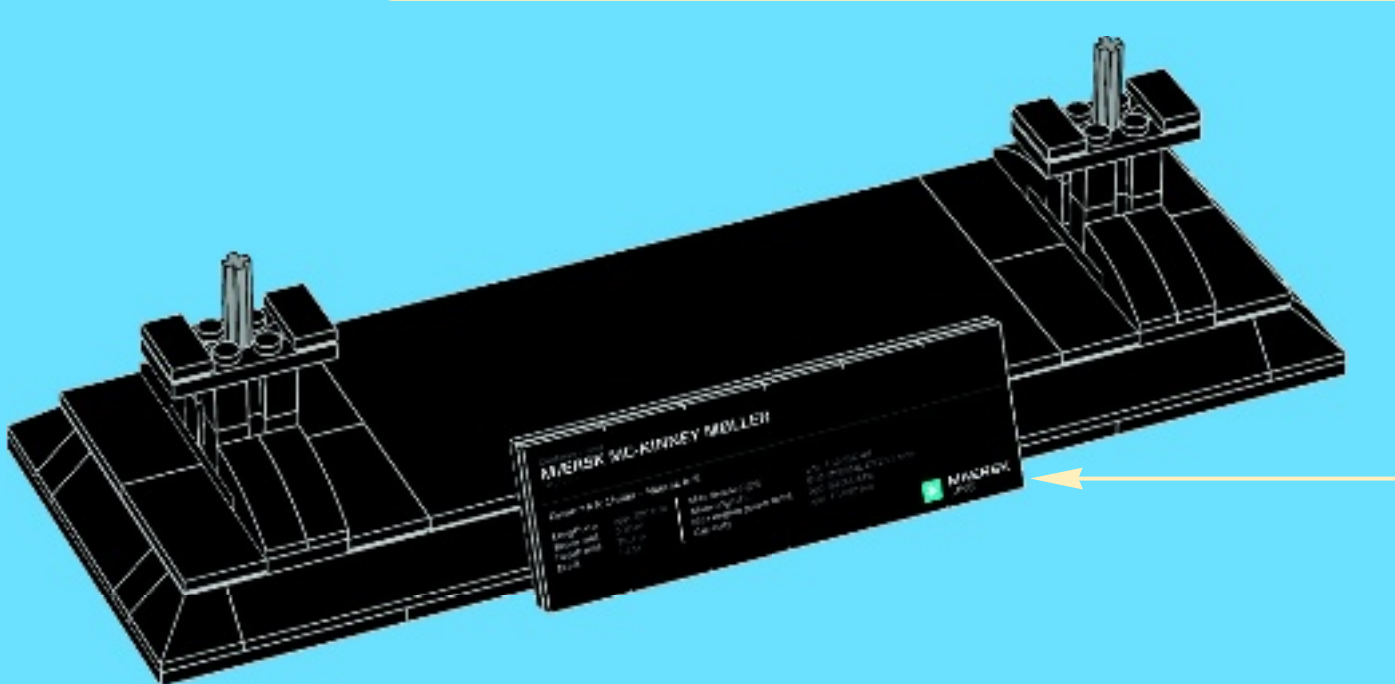
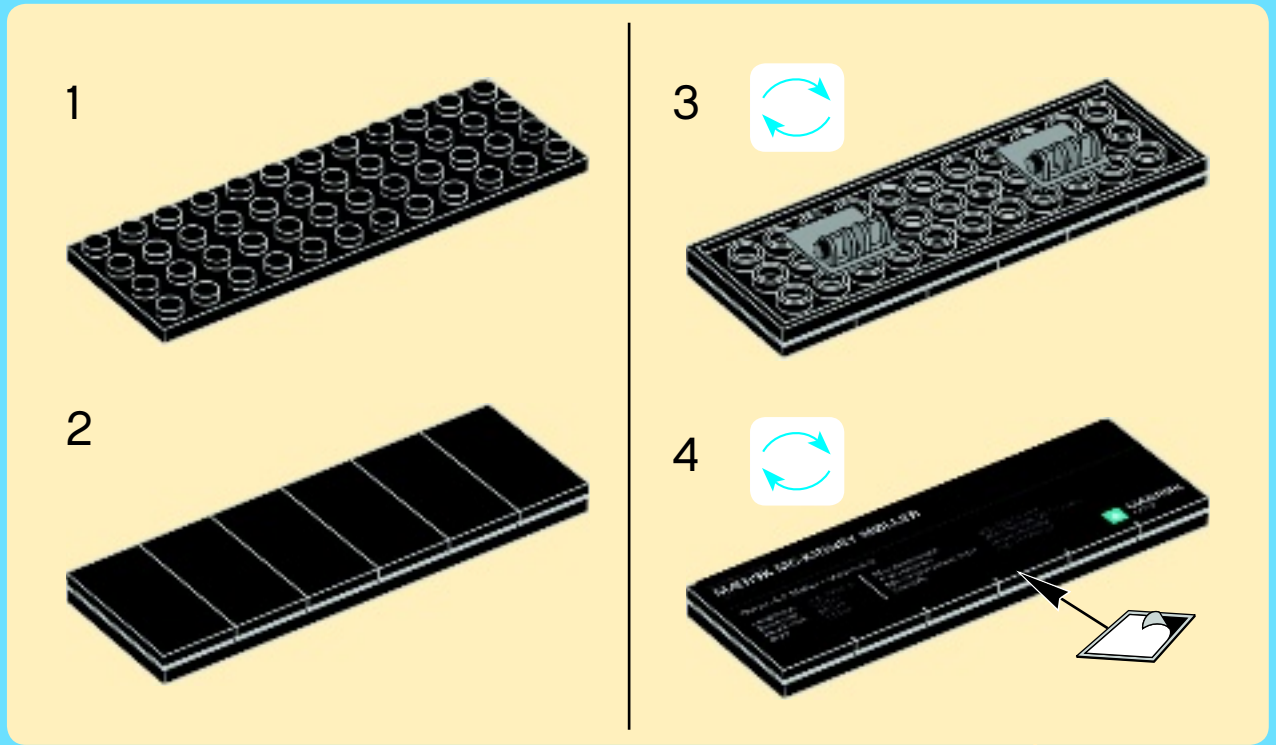

86





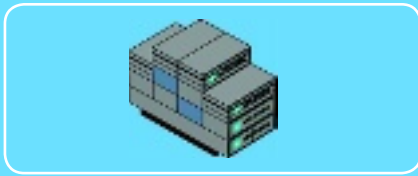
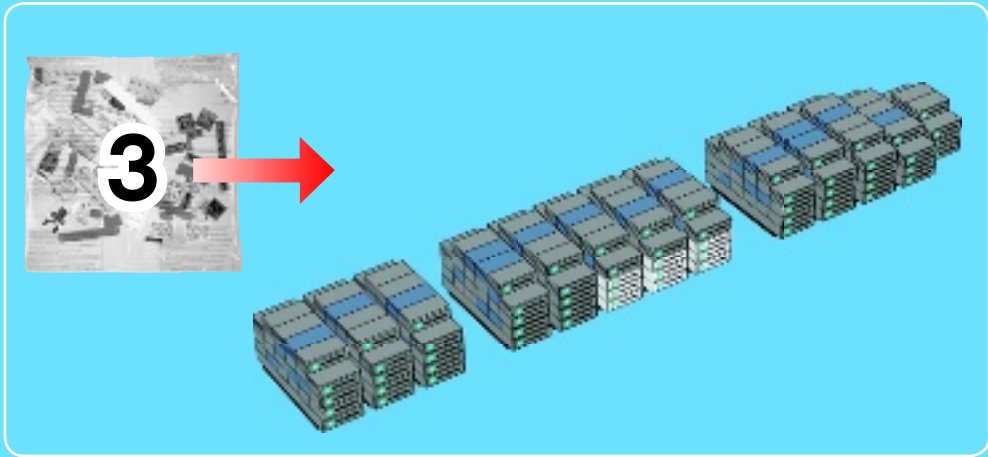

1

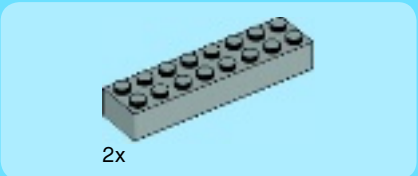

2

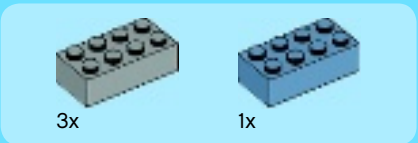
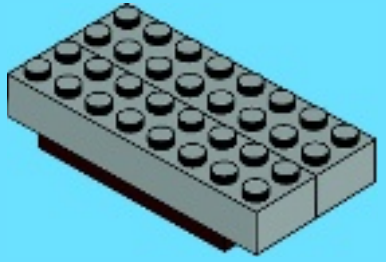

3

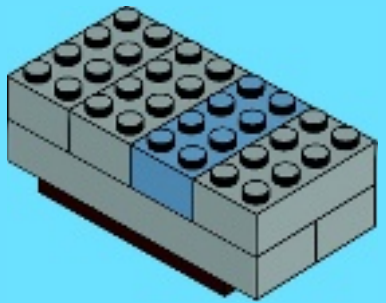

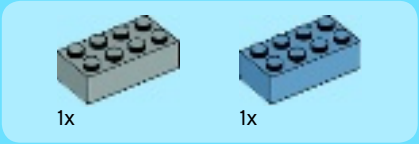

4

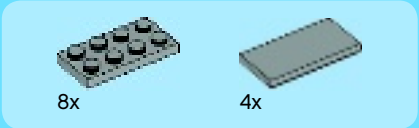
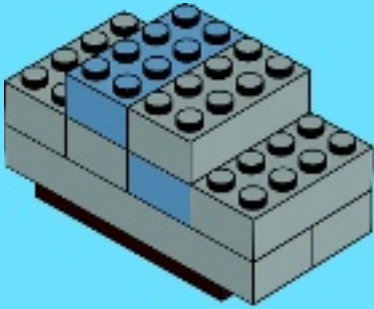

5

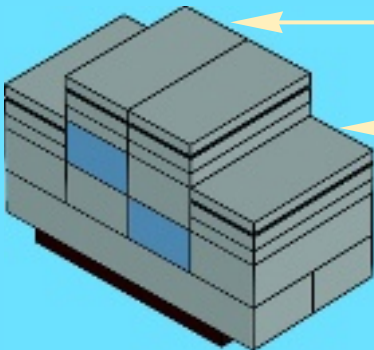
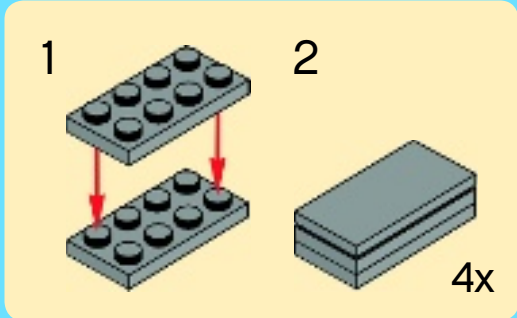

6

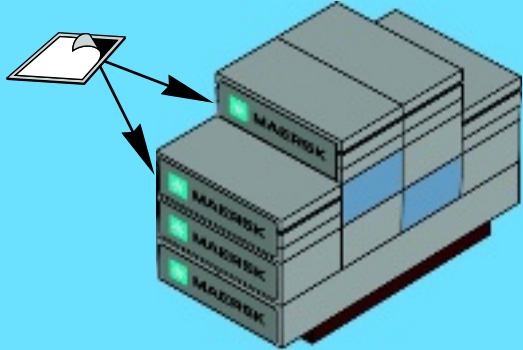

7

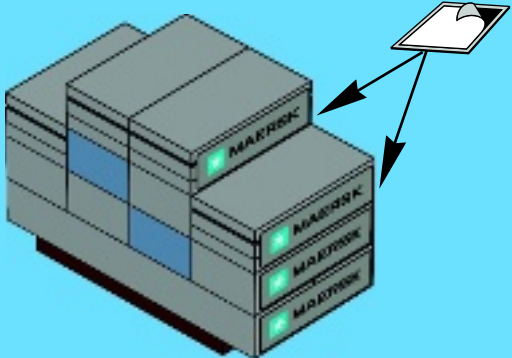

87





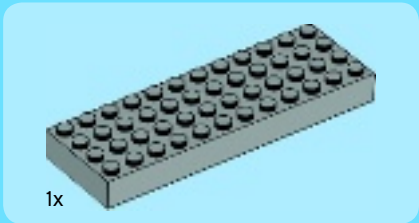
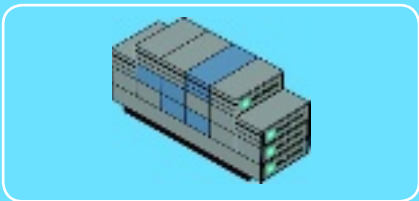

1

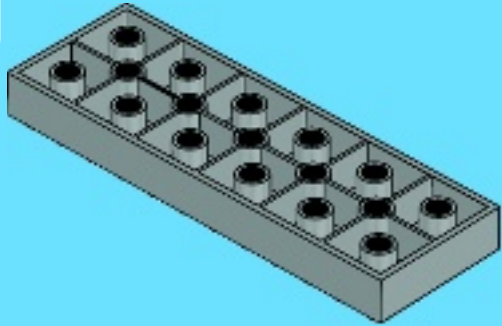

2

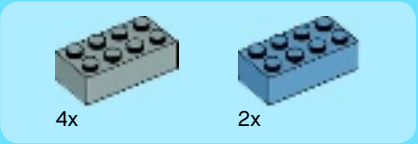
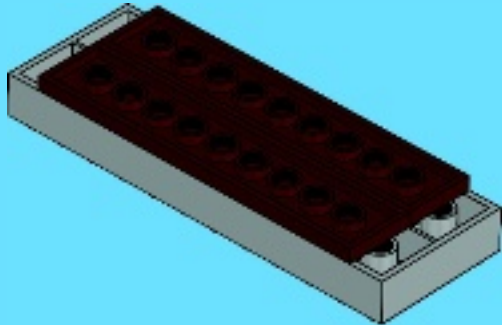

3

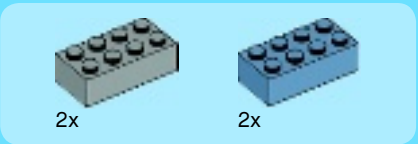
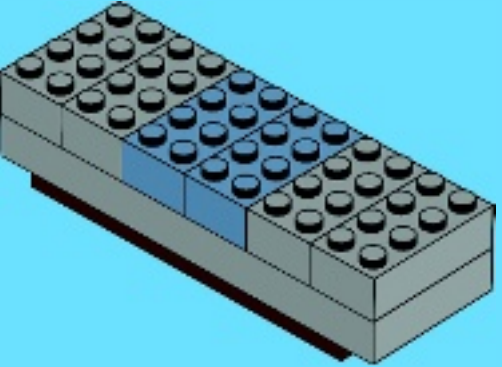

4

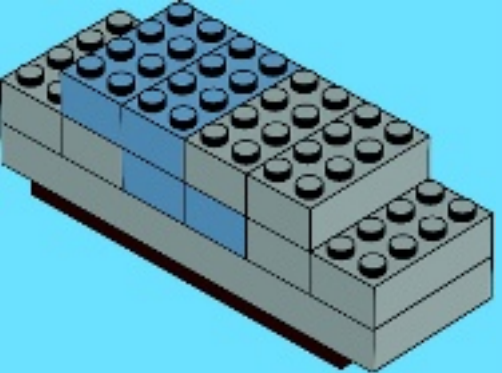

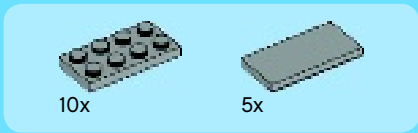

5

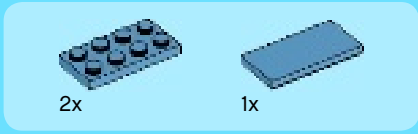
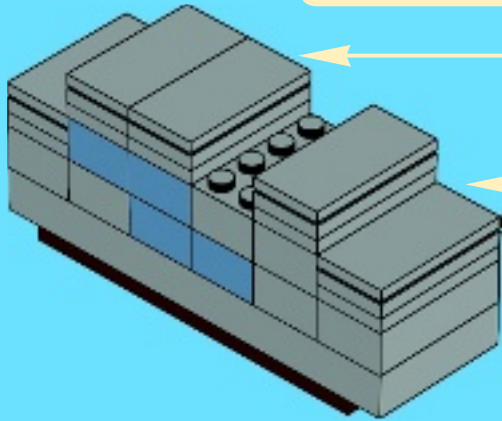
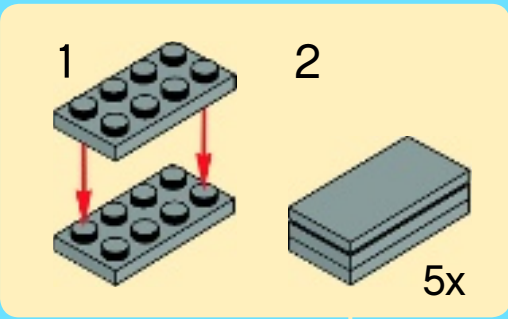

6

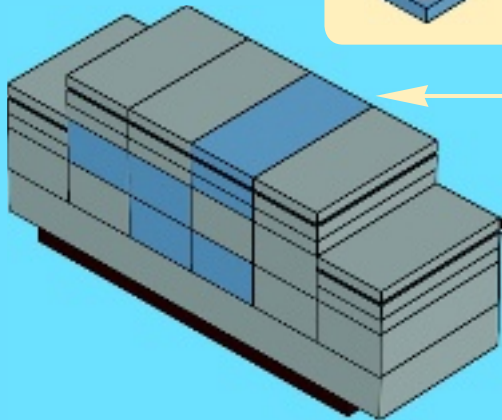
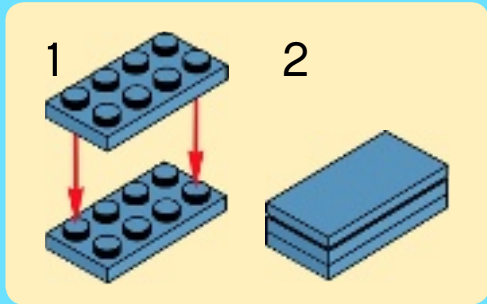

7

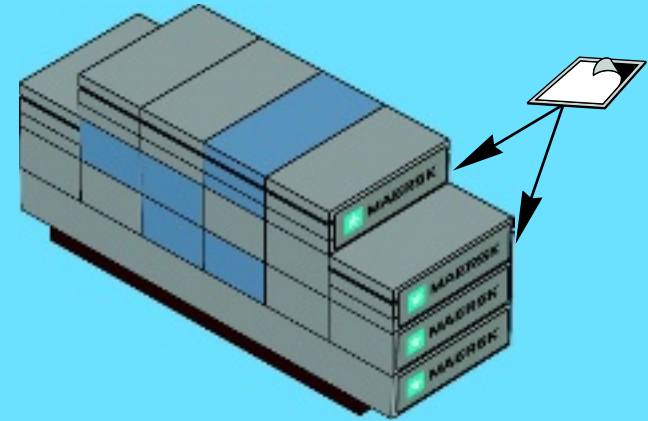

8

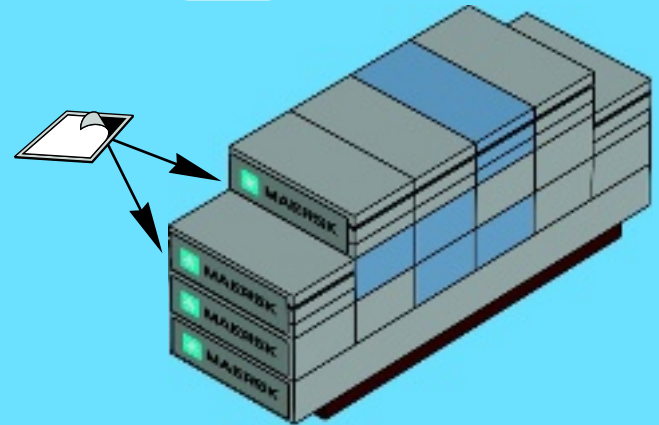

88

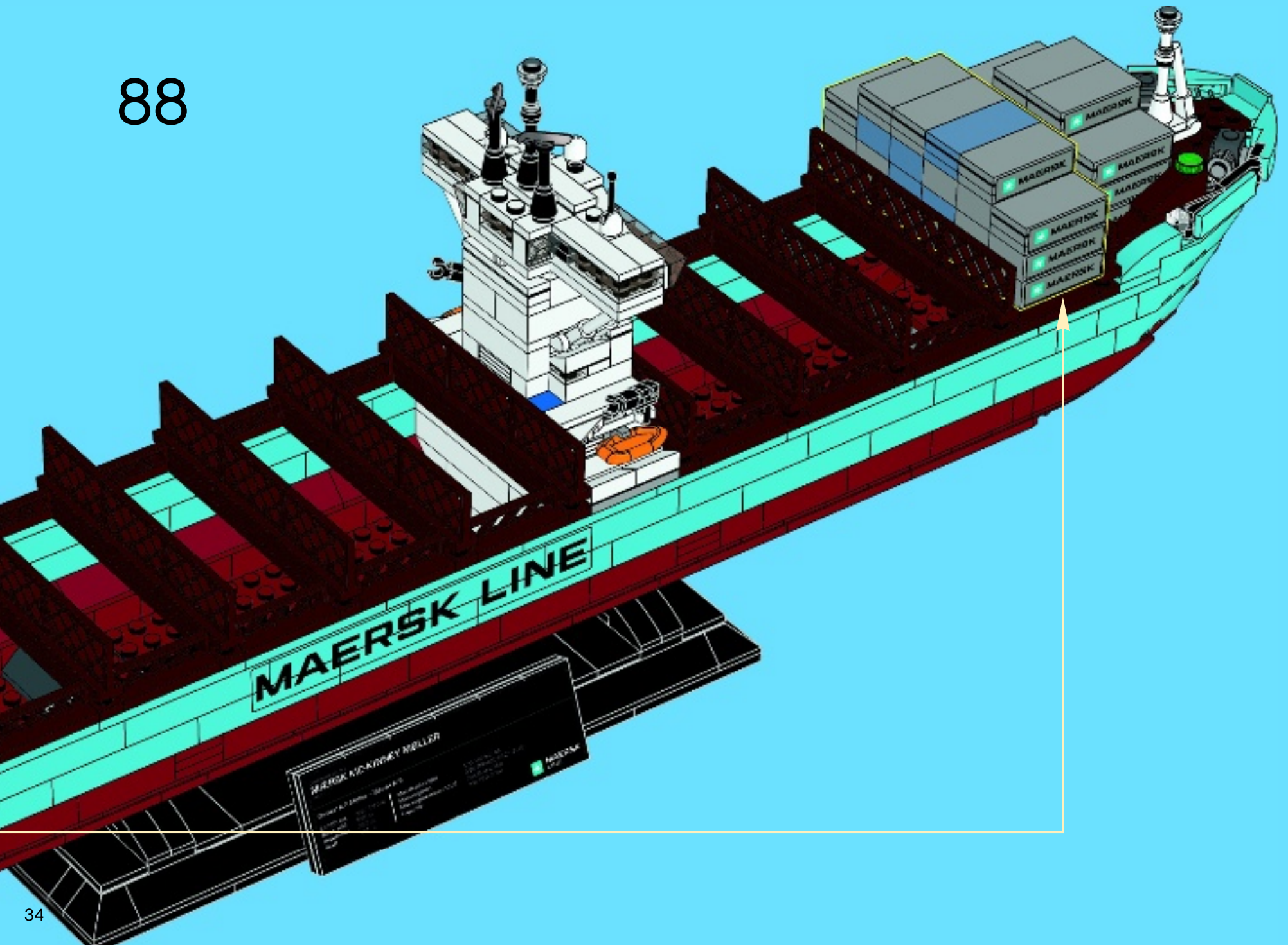



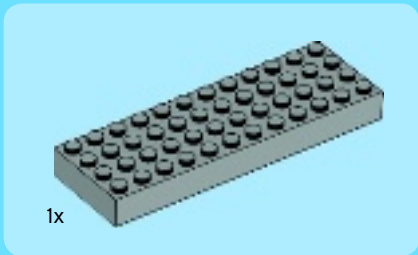
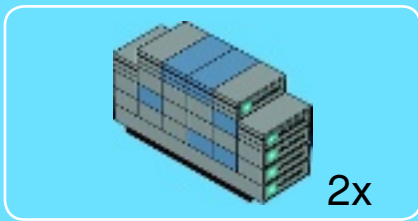

1

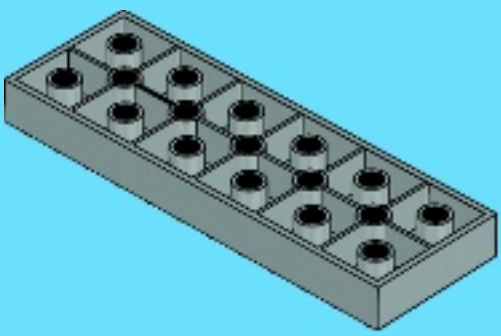

2

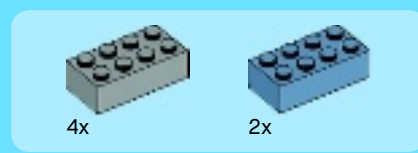
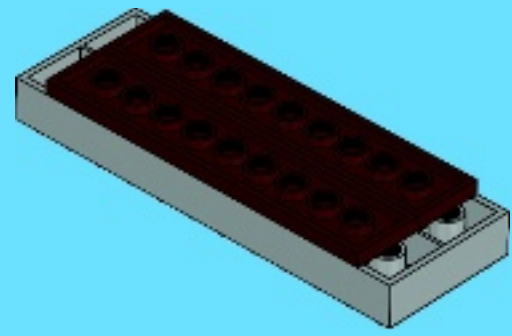

3

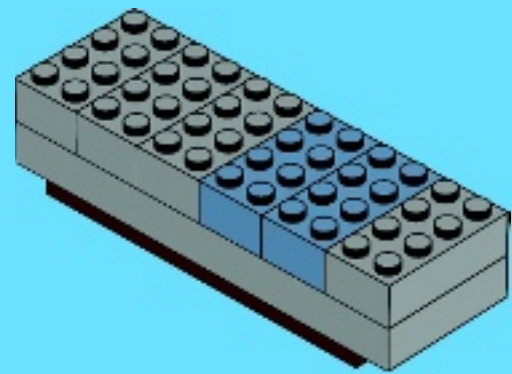

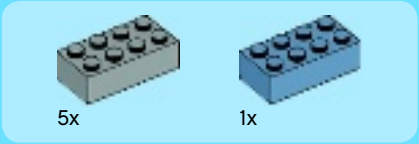

4

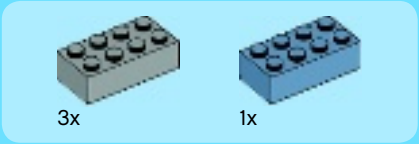
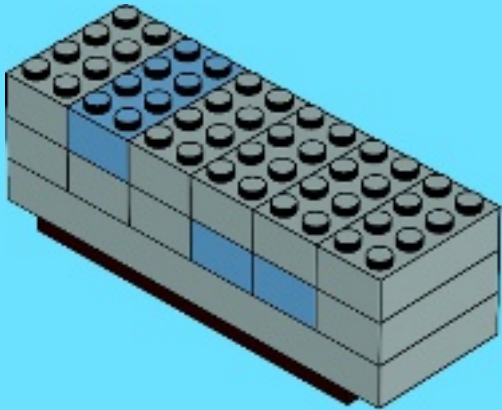

5

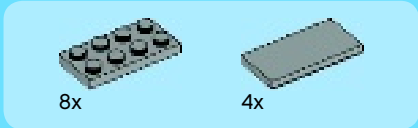
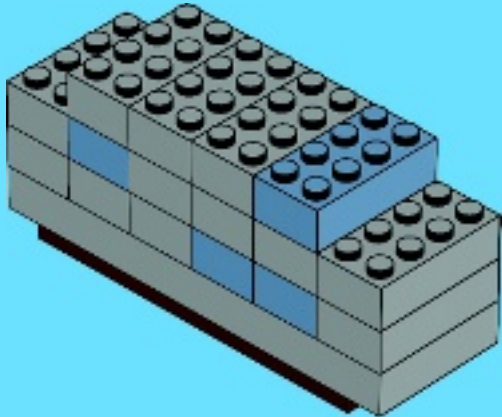

6

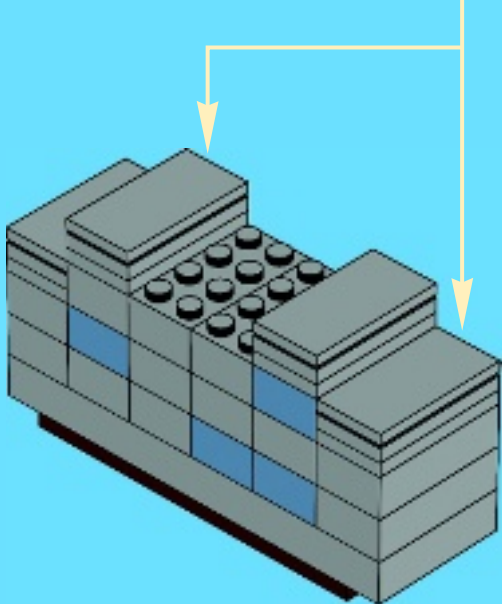
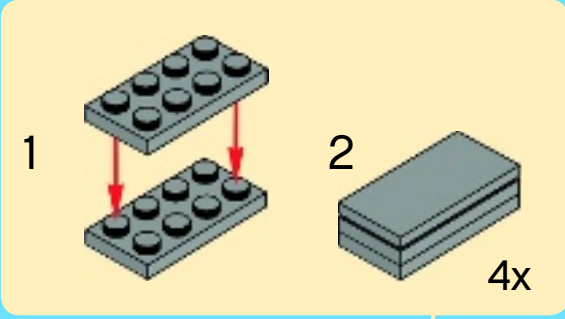

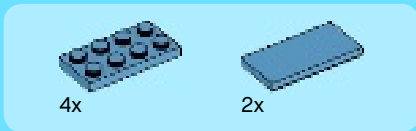

7

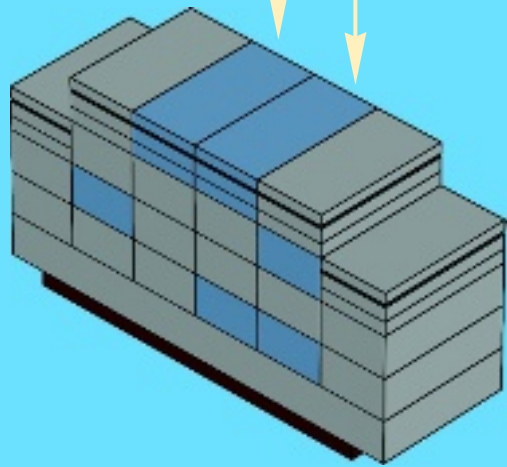
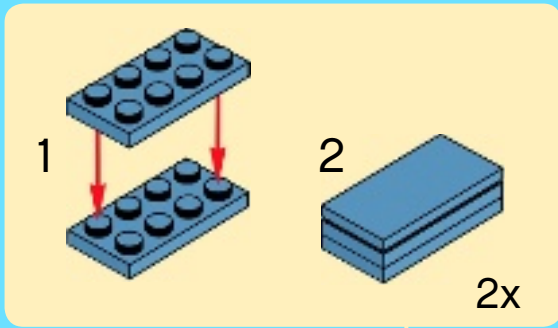

8

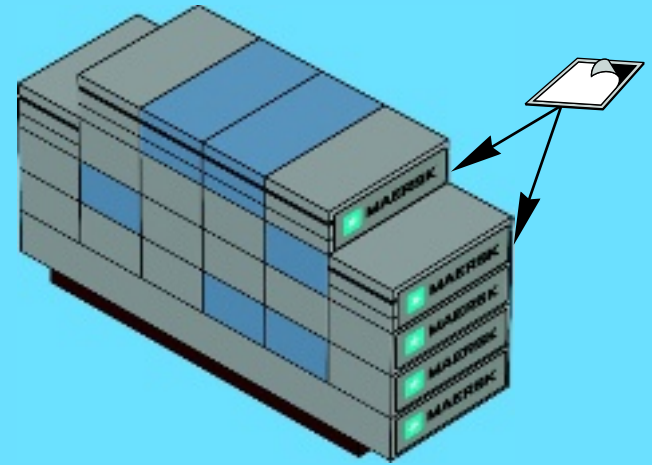

9

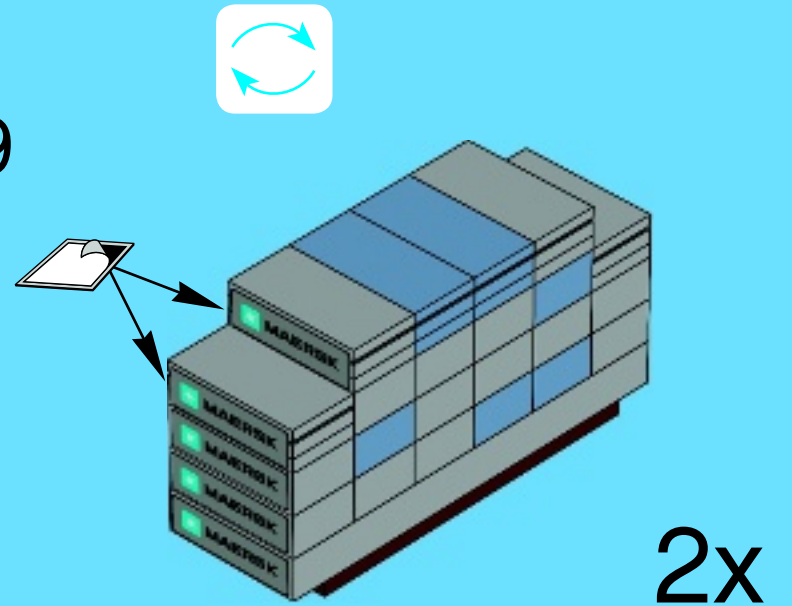



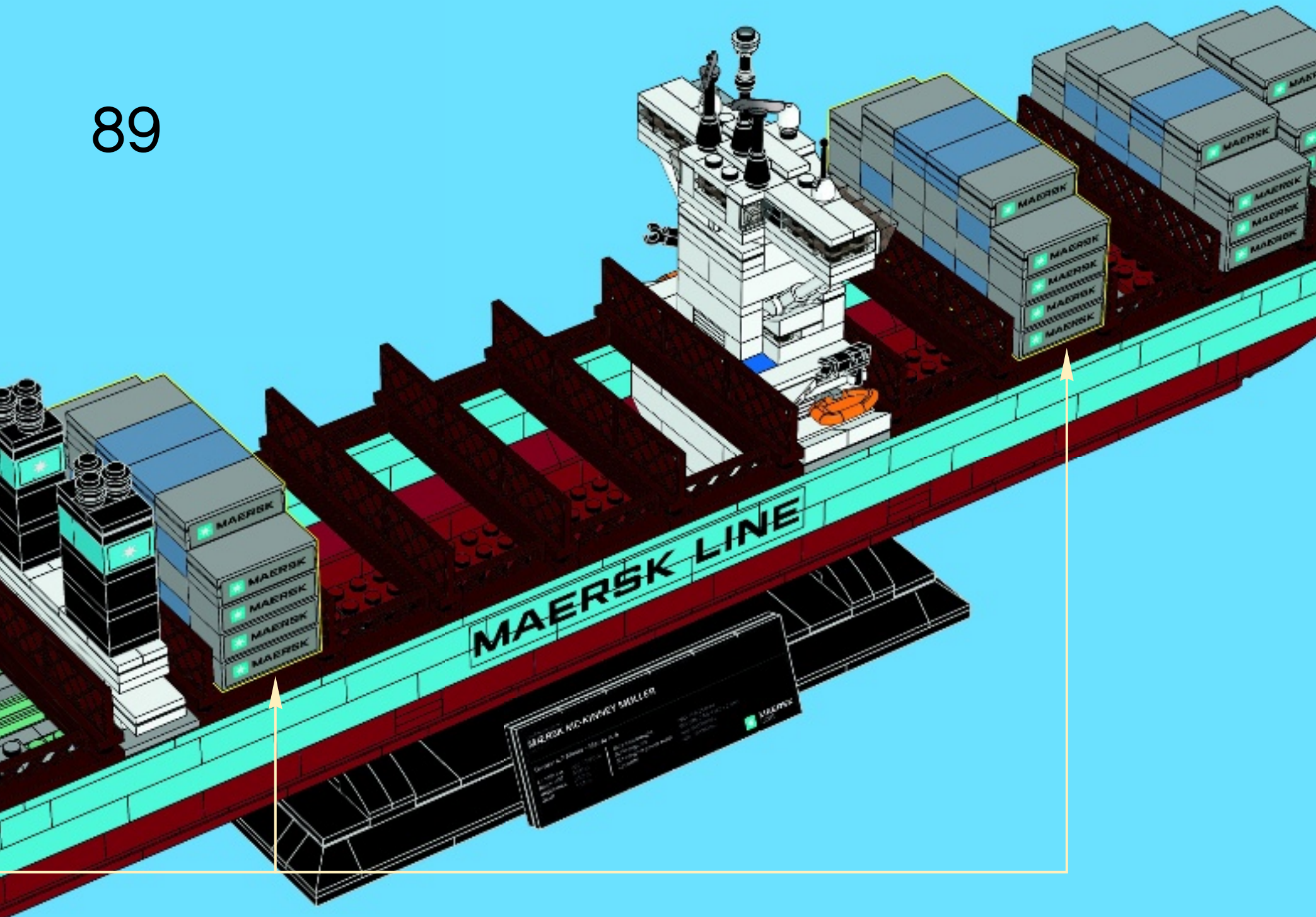

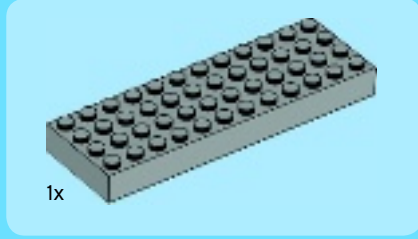
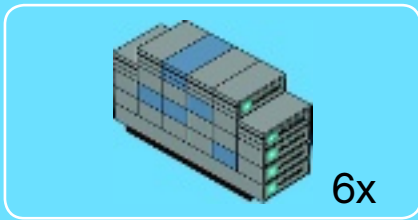

1

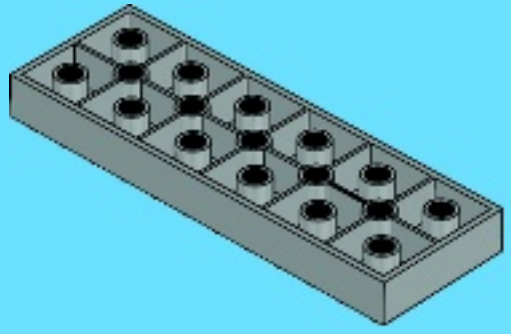

2

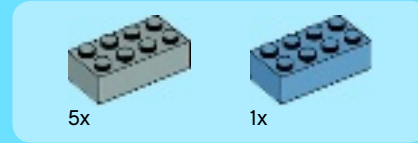
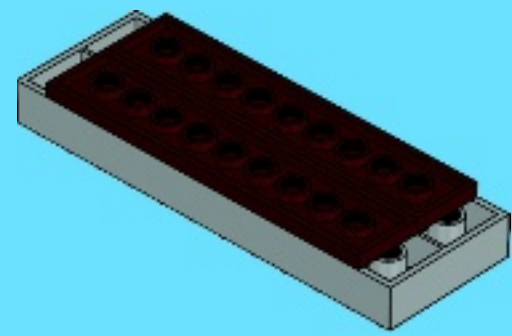

3

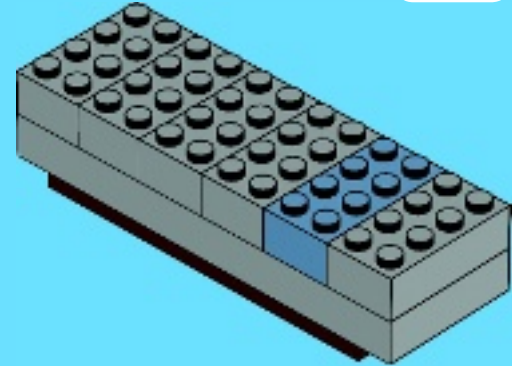

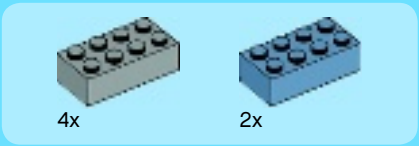

4

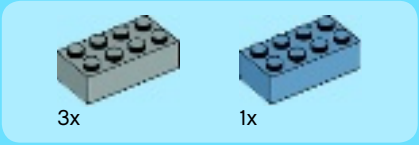
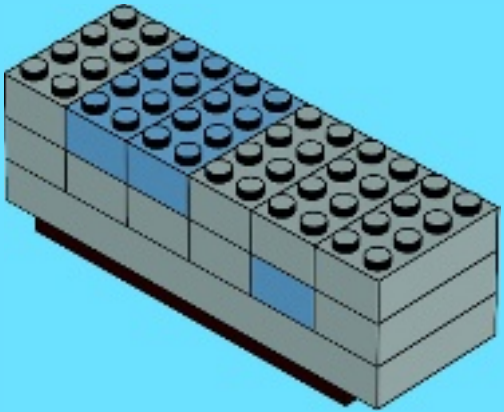

5

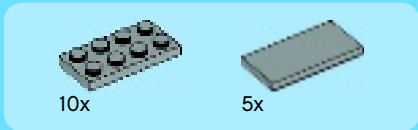
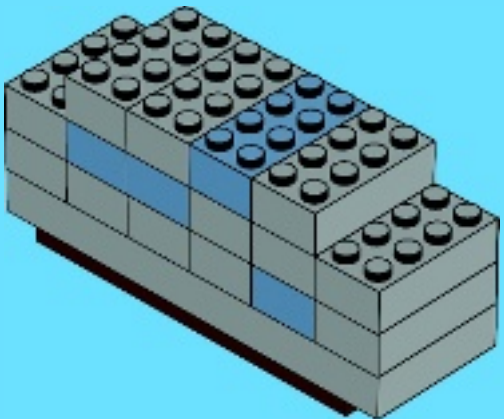

6

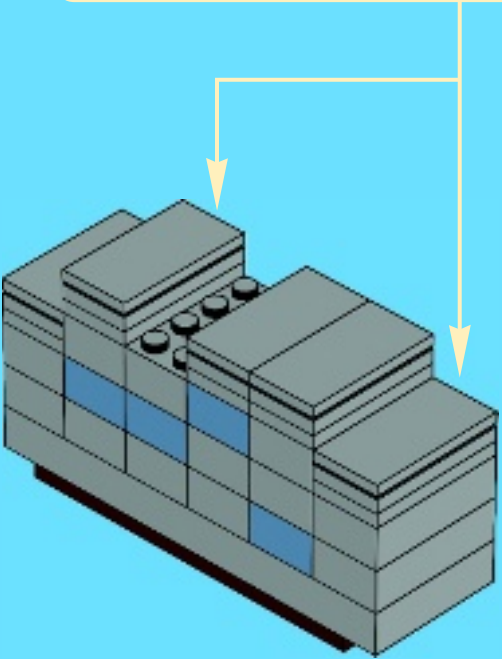
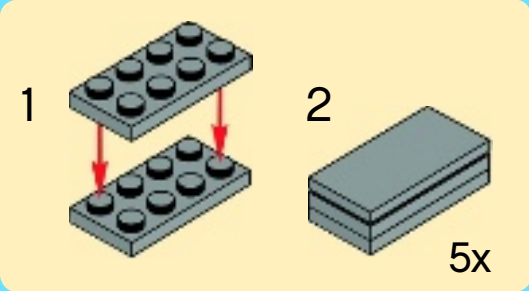



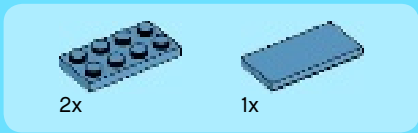

7

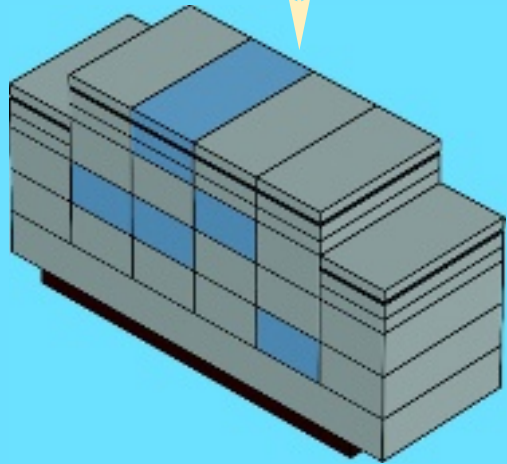
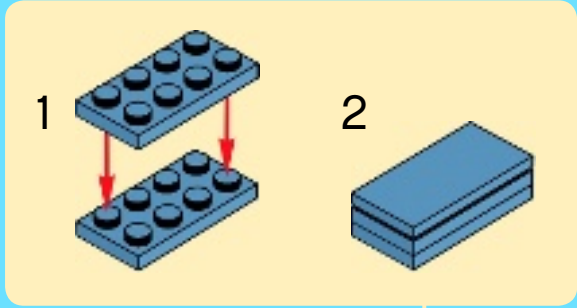

8

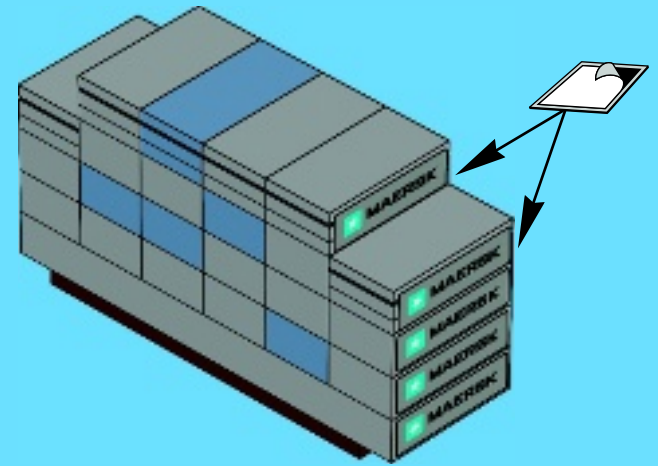

9

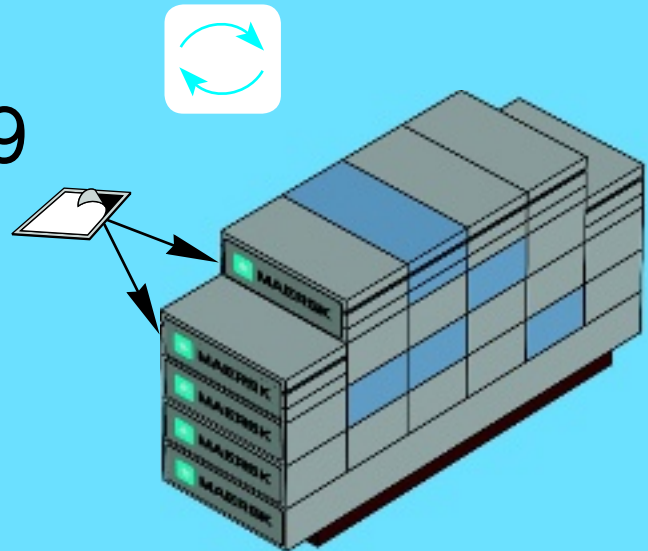

6x

90

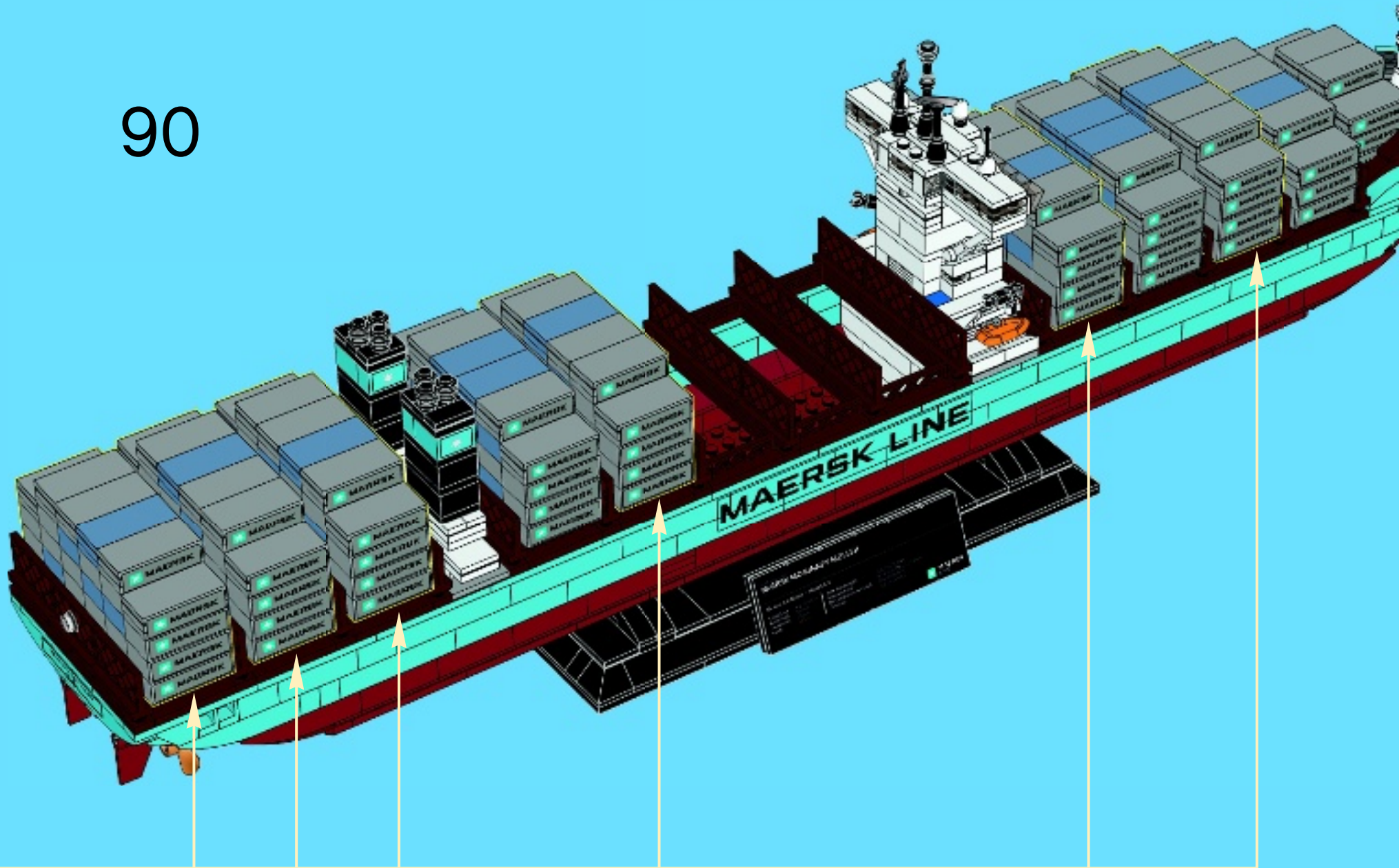

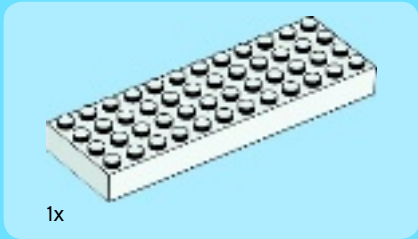
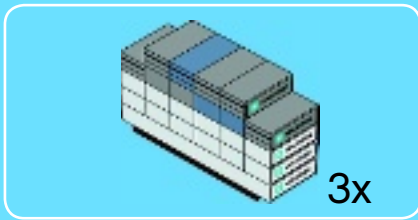

1

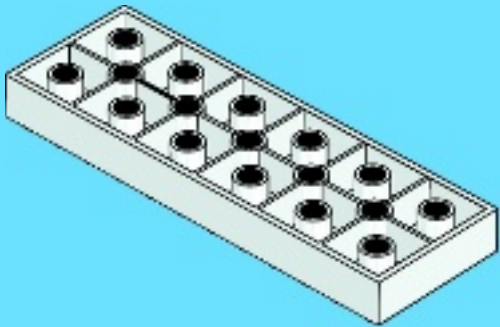

2

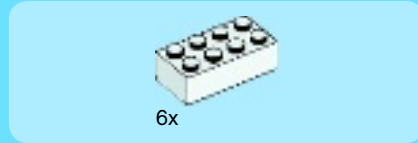
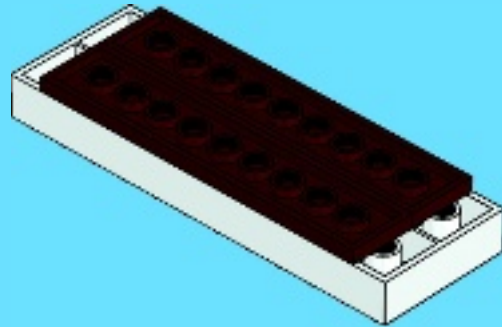

3

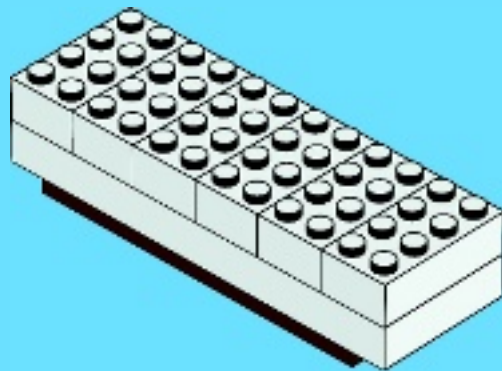





6x

4

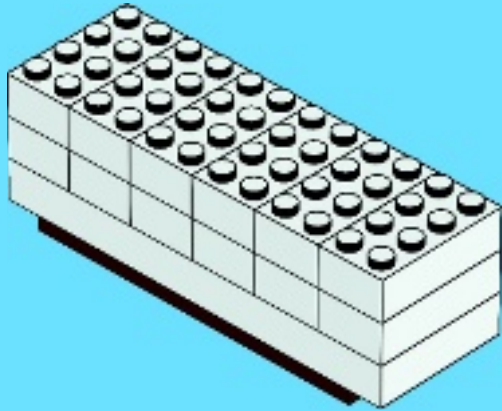

2x



2x

5

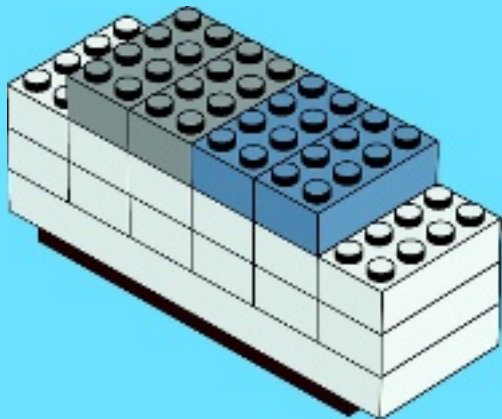

10x



5x

6

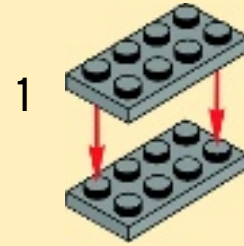

1

2

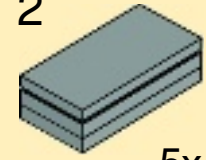

5x

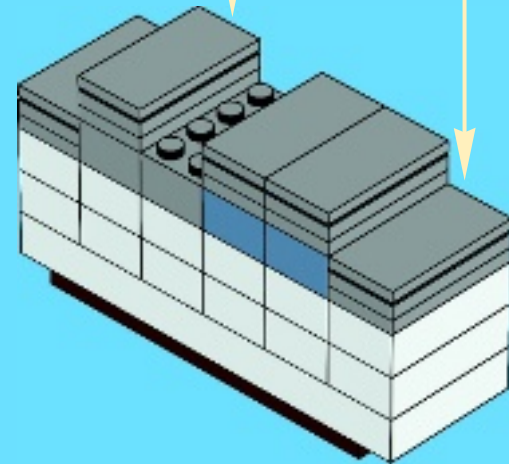

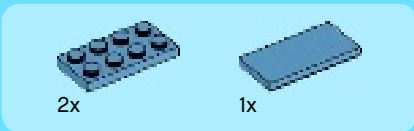

7

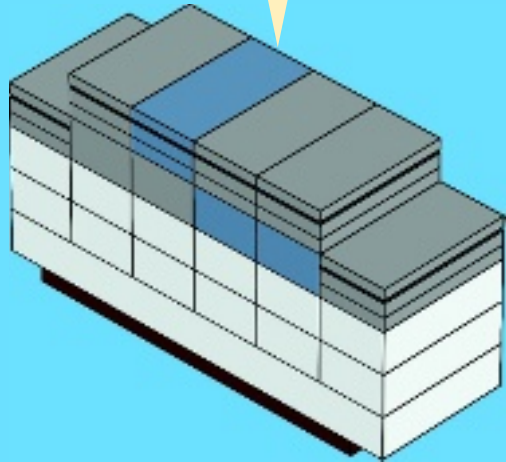
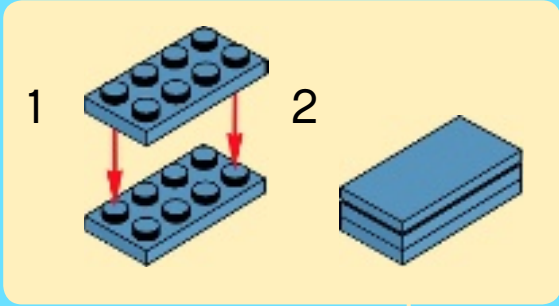

8

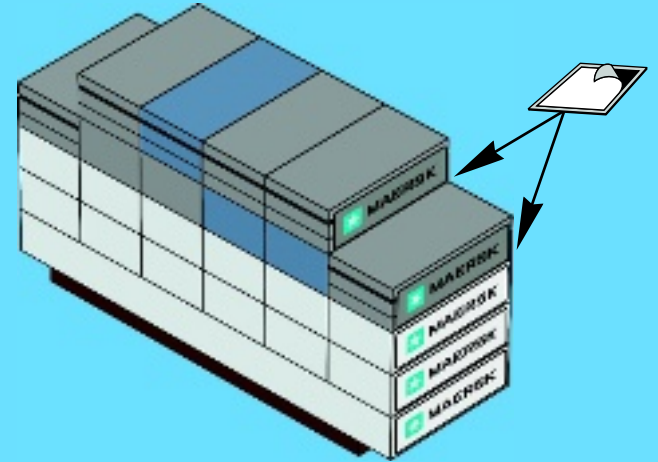

9

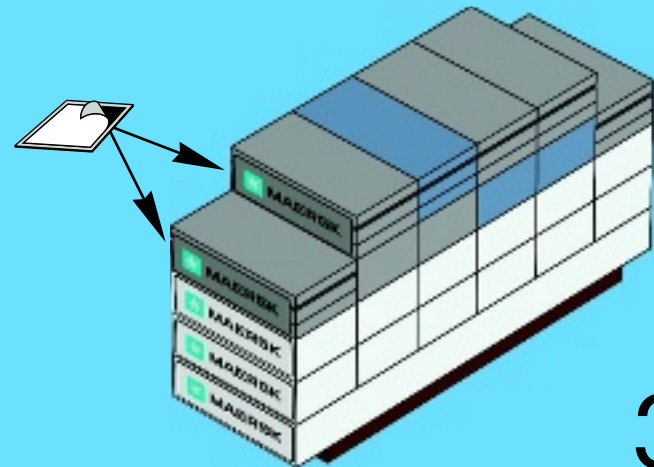

3x

91

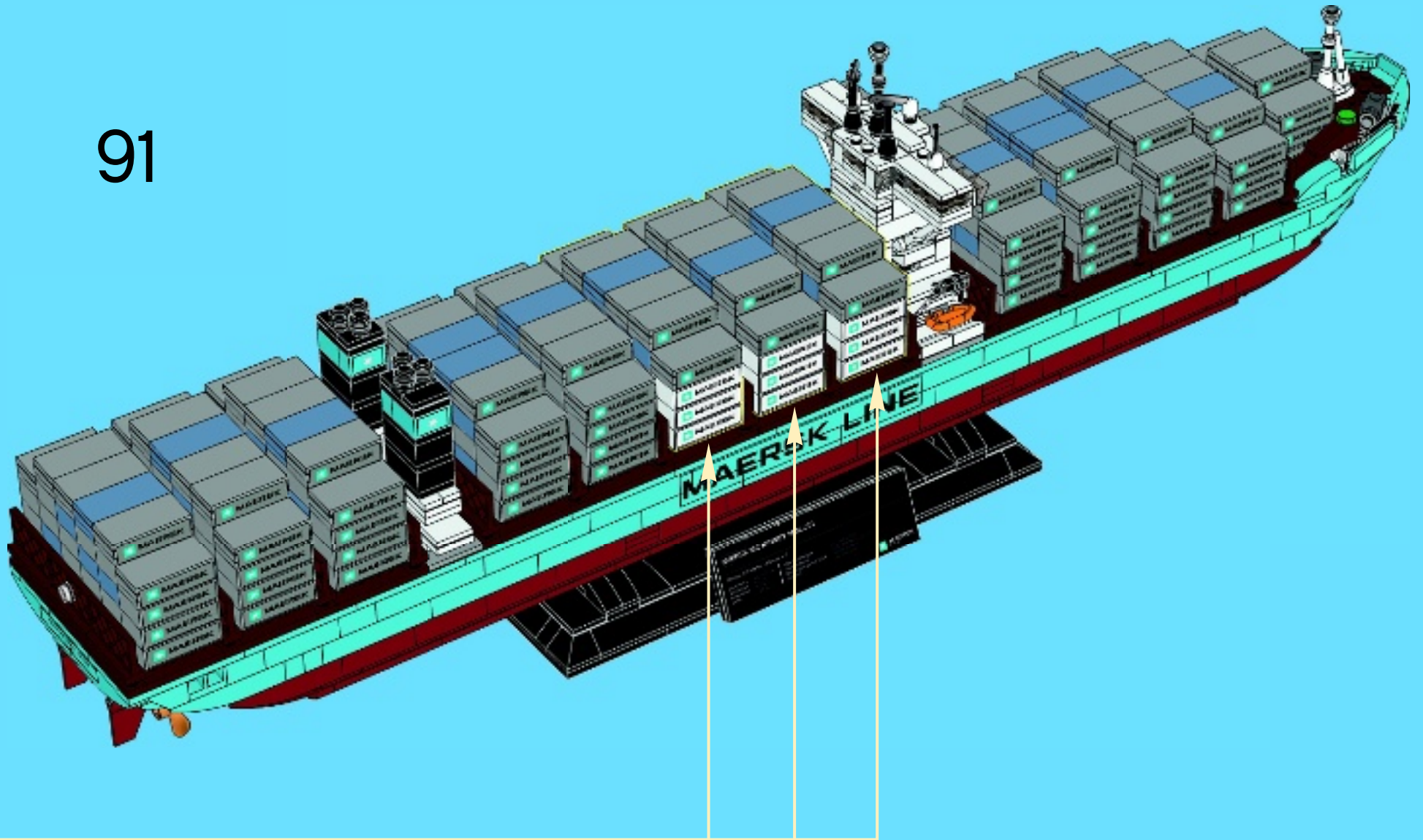





4x  
287701

2x  
362201

9x  
301001

44x  
300101

8x  
300901

4x  
407001

1x  
4518400

6x  
4547489

3x  
307001

6x  
302401

23x  
6051511

7x  
306901

8x  
302301

5x  
306801

2x  
243201

5x  
4515364

48

5x  
302201

2x  
4613256

2x  
4282737

1x  
4179875

1x  
4179874

9x  
243101

9x  
371001

9x  
302001

2x  
366601

2x  
379501

1x  
447701

4x  
383201

3x  
6052797

4x  
4249506

2x  
73737

6x  
6056663

1x  
4623199

1x  
6040333

5x  
6052824

6x  
300226

6x  
6052796

3x  
4529236

8x  
4121966

4x  
4189064

3x  
303726

8x  
4251161

2x  
379426

6x  
306926

2x  
4517925

2x  
302326

8x  
302126

14x  
4560182

5x  
366626

2x  
373826

5x  
4163334

5x  
303326

1x  
302926

1x  
4603646

1x  
6048855

2x  
4535739

2x  
4515368

8x  
370926

14x  
614126

27x  
4278359

3x  
4653208

1x  
4598897

2x  
6052829

2x  
6015891

4x  
393726

2x  
4124096

4x  
4109810

8x  
4121715

6x  
4512363

3x  
370526

1x  
4631857

2x  
626440

3x  
3005740

2x  
4594686

1x  
4646864

1x  
4646860

14x  
6001197

14x  
4244368

44x  
6052830

14x  
6052832

28x  
6052827

16x  
6009656

4x  
6057579

10x  
6052779

24x  
6057585

12x  
4211525

4x  
4541379

4x  
6052777

5x  
6057588

1x  
6028338

3x  
6052785

10x  
4531415

4x  
4590811

58x  
6052917

3x  
4609925

6x  
6052920

18x  
4541380

16x  
6052914

2x  
6052768



2x  
6052772



1x  
4539069



1x  
4539068



2x  
6056645



12x  
4539097



6x  
4541510



3x  
4618986



1x  
6020122



4x  
6052765



2x  
6009130



6x  
6052874



1x  
4541544

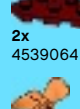

2x  
4539064



2x  
6052776



1x  
4211193



4x  
4620075



4x  
4211197



4x  
4219726



2x  
4211194



1x  
421186



1x  
4271874



3x  
4211211



16x  
4223683



24x  
4211214



3x  
6052822



2x  
4565214

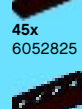

45x  
6052825



24x  
6052826



15x  
6055145



1x  
4211401



9x  
6052831



4x  
4211860



2x  
6037399



117x  
4211385



2x  
4211805



2x  
4211481

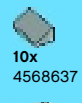

10x  
4568637



8x  
6066097



4x  
4565393



2x  
4558169



10x  
4211429



7x  
4599498



64x  
4560183



124x  
4211395



8x  
4521921



2x  
4541978



2x  
4594238



8x  
4632575



2x  
4654582



4x  
4211632



1x  
6015344

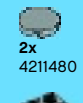

2x  
4211480



2x  
4211881

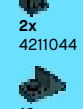

2x  
4211508



2x  
4211044



10x  
4621917



2x  
4210862



6x  
4218188



1x  
4210637



12x  
4210719



2x  
4211002



2x  
4210998



4x  
4211042



2x  
4210469



16x  
4655241



2x  
4618133



5x  
4619652



15x  
6004945

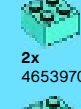

2x  
4653970



3x  
6052877



7x  
4625629



35x  
4619653



3x  
6022000



2x  
6052795



2x  
6035598



2x  
6052823



12x  
6052790



2x  
4619511



2x  
4619513

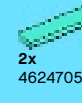

2x  
4624705

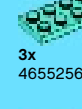

3x  
4655256

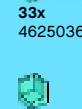

33x  
4625036



4x  
4618645



1x  
4618647



3x  
6052787



1x  
4206330



2x  
370224



2x  
6052833



1x  
4654448



1x  
4654448



1x  
4654448



1x  
4654448



1x  
4654448

Customer Service  
Kundenservice  
Service Consommateurs  
Servicio Al Consumidor  
[LEGO.com/service](https://www.lego.com/service) or dial







# Join the LEGO® VIP Loyalty Program!

## Nehmen Sie am LEGO® VIP-Programm teil!

## Rejoignez le programme de fidélité LEGO® VIP !

Earn points towards valuable rewards every time you shop!



Get 1 VIP Point for every Dollar, Pound or Euro spent!\*

\*For other exchange rates, please see [VIP.LEGO.com](http://VIP.LEGO.com)



For every 100 Points you earn, enjoy a \$5 / £5 / 5€ reward!

Sammeln Sie bei jedem Einkauf Punkte für wertvolle Prämien!



Erhalten Sie 1 VIP-Punkt für jeden Euro, Pfund oder Dollar, den Sie ausgeben!\*

\*Den Umrechnungsfaktor für andere Währungen erhalten Sie auf [VIP.LEGO.com](http://VIP.LEGO.com)



Für 100 VIP-Punkte erhalten Sie eine Prämie von 5€ / £5 / \$5!

Gagnez des points à chaque achat et obtenez de formidables récompenses !



Gagnez 1 point VIP pour chaque euro, livre ou dollar dépensé !\*

\*Pour d'autres taux de change, veuillez visiter [VIP.LEGO.com](http://VIP.LEGO.com)



Par tranche de 100 points gagnés, bénéficiez d'une récompense de 5 € / 5 £ / 5 \$ !



Redeem your rewards in LEGO Stores and [shop.LEGO.com](http://shop.LEGO.com).

Lösen Sie Ihre Prämien in den LEGO Stores und auf [LEGO.com/shop](http://LEGO.com/shop) ein.

Utilisez vos récompenses dans les LEGO Stores et sur [LEGO.com/shop](http://LEGO.com/shop).



- Enjoy early access to new LEGO products and promotions!
- Access special LEGO sets and goodies not available for anyone else!

**Plus much, much more!**

- Kaufen Sie neue exklusive LEGO Produkte, noch vor dem eigentlichen Verkaufsstart!
- Erhalten Sie Zugang zu besonderen LEGO Sets und Vorteilen, die es nur für LEGO VIPs gibt!

**Und vieles mehr!**

- Bénéficiez d'un accès en avant-première à des nouveautés et promotions LEGO !
- Accédez à des cadeaux et ensembles LEGO spéciaux réservés aux membres !

**Et bien d'autres choses encore !**

Visit [VIP.LEGO.com](http://VIP.LEGO.com) for more information!

Besuchen Sie [VIP.LEGO.com](http://VIP.LEGO.com) für weitere Informationen!

Rendez-vous sur [VIP.LEGO.com](http://VIP.LEGO.com) pour en savoir plus !







# CREATOR

10224

10232

10243



EXPERT





# CREATOR

LEGO.com/creator

## YOUR OPINION COUNTS! VOTRE OPINION NOUS INTÉRESSE !

Answer a few questions about your new LEGO® product and you could **win** a prize!  
Please visit:

[LEGO.com/productfeedback](http://LEGO.com/productfeedback)

No purchase necessary. Open to all residents where not prohibited.



**DEINE MEINUNG ZÄHLT!**  
Beantworte einige Fragen über unser neues LEGO® Produkt und gewinne mit etwas Glück einen Preis!  
Besuche uns auf:  
[LEGO.com/productfeedback](http://LEGO.com/productfeedback)

Die Teilnahme ist nicht an einen Einkauf gebunden.  
Teilnahme in allen nicht ausgeschlossenen Ländern möglich.

**VOTRE OPINION NOUS INTÉRESSE !**  
Répondez à quelques questions sur notre nouveau produit LEGO® et vous gagnerez peut-être un prix !  
Rendez-vous sur :  
[LEGO.com/productfeedback](http://LEGO.com/productfeedback)

Sans obligation d'achat.  
Ouvert à tous les résidents des pays autorisés.

**GEEF JE MENING!**  
Beantwoord een paar vragen over je nieuwe LEGO® product en maak kans op een prijs!  
Ga naar:  
[LEGO.com/productfeedback](http://LEGO.com/productfeedback)

Geen koopverplichting.  
Deelname toegestaan waar geen enquêteverbod geldt.

みなさまのご意見をお聞かせください！  
レゴ®新製品について、いくつかの質問にお答えください。お答え頂いた方には抽選でプレゼントをお渡しします。  
以下のサイトをご覧ください：  
[LEGO.com/productfeedback](http://LEGO.com/productfeedback)

お買い上げ頂く必要はありません。  
どなたでもご利用いただけます。  
(法律で禁止されている国を除く)

EXPERT